



RX12_{GPS}

OWNERS MANUAL



PGA is a registered trade mark of the Professional Golfers' Association Limited.

POWAKADDY.COM



Thank you for purchasing the all new Powakaddy. Please read the following instructions carefully. Battery care is very important, please refer to Section 12 for detailed instructions.

When you receive your new Powakaddy you will have the following:

- | | |
|-----------------|---------------------------------|
| 1 x Trolley | 1 x Front Castor Wheel Assembly |
| 1 x Battery | 1 x Front Bungee Strap |
| 1 x Charger | 1 x Instruction Pack |
| 2 x Rear Wheels | 1 x Handset & Charging Cable |

CONTENTS

1. PRODUCT WARRANTY	3	7. POWAKADDY APP	13
2. PRODUCT SAFETY	3	Firmware Updates	
Attach the Wheels		Notifications	
Anti-Tip Wheel		Scorecards	
3. GETTING STARTED	4	Report a Mapping Error	
Unfolding the Frame		Select a Course	
Lithium Battery		8. GPS FUNCTIONS	15
Front Castor Wheel Adjustment		Active Green View	
Handle Height Adjust		Drop Pin	
Mag-Lok [®]		Full Hole View	
Manual Operation		Change Hole	
Remote Operation		Clock Functions	
4. MODES OF OPERATION	8	Shot Distance	
Remote Status Indicator		Competition Mode	
Remote Handset Controls		Recording Scores	
Motor Calibration		Statistics	
Pairing Remote Handset		9. SCORING	18
Charging the Handset		10. END ROUND	19
USB-C Charging Port		Score Settings	
5. REMOTE HANDSET	9	Trolley Settings	
Battery Gauge		About	
Touch Display		11. SETTINGS	20
Motor Controls		Charging Instructions	
ADF (Automatic Distance Function)		Battery Safety	
EBS (Electronic Braking System)		Charging Safety	
6. CONTROLS OVERVIEW	12	12. BATTERY CARE	21
Pairing		Lithium Battery Storage	
Update Software		Battery Transportation	
Update Maps		13. MAINTENANCE	22

If unable to locate required information within this manual, please visit www.Powakaddy.com/Support where you will find our trolley product FAQ's. Alternatively contact the Powakaddy Customer Service team.

PRODUCT WARRANTY



Register now! Don't miss out!

Scan to open the registration page
or visit: powakaddy.com/my-powakaddy

Please take a moment to register your new product.

You will be required to enter the serial numbers for the Trolley, Battery and Charger. These are located on the individual items. The serial number on the trolley is located in the rear joint, see image.

**Terms and conditions apply. See powakaddy.com for details.*



PRODUCT SAFETY

Before heading out on course, it is highly advisable to first use your brand new PowaKaddy Trolley in a wide-open area to familiarise yourself with the remote characteristics of the trolley. Preferably use on grass with your golf bag secured to the trolley. The speed, turning and braking characteristics of the trolley will be affected by the surface the trolley is used on.

Note: the trolley is optimised for a bag weight of up to 14kg. An excessively light or heavy bag will affect trolley performance.

Common sense should be applied when using the trolley in remote mode. The trolley does not react well with impacts to cars, trees, bunkers, and immersions in ponds and ditches. Please follow the guidelines listed below:

1. The trolley is not designed to transport people; do not ride on your RX Trolley.
2. Do not transport any other equipment other than what the product is intended for. A PowaKaddy cart bag is the preferred bag of choice for a secure fit.
3. Use the manual control mode when in confined spaces, especially in car parks near and around the club house and pro shop to ensure you have complete control of the product.*
4. Do not aim the trolley at other people or golf trolleys.
5. Do not drive the trolley through puddles or standing water.
6. Only operate the golf trolley using the remote if there is an uninterrupted line of sight between you and the product.
7. The Product is not a toy. The product is not to be used by children unless supervised by an adult or sufficient safety guidance listed within this manual and safety instruction sheet, provided in the instruction pack is followed.

Note: although the remote has up to a 100 metre range**, we advise to use the remote only where the trolley and hazards are visible.

Do not attempt to steer the trolley manually when operated in Remote mode. The trolley will attempt to run straight and at a continuous speed. Press and rotate the control dial to take over in manual mode.

*PowaKaddy International Ltd cannot take responsibility for damage or injury caused by improper use.

**100 metre range dependent on terrain, clear line of sight between handset & trolley, and external electrical interference.

For further information, please refer to the Product Safety guide provided with the trolley and visit the PowaKaddy website.

GETTING STARTED

Attach the Wheels

Remove the front castor wheel assembly, wheels, and frame from the box.

Remove the axle caps and fit the wheels by pressing the release button located on the hub and slide onto the axle until the wheel is touching the black clutch. For ease during transport and storage purposes, the wheels can be inverted.

Note: The wheels can be locked into two positions on the axle; push onto the inner groove to engage the clutches. The outer groove can be used when drive is not required.

Slide the front wheel assembly into the frame and secure using the two hex screws and washers provided in the pack. Tighten using the hex key supplied. Note: please save the hex key for adjusting the handle height and attaching the accessory station bolt (supplied in the manual pack).



Anti-Tip Wheel

Always use the Anti-tip Wheel!
When arriving at the course, rotate it from underneath the Powafame until it locks into place, sticking out from the rear of the trolley.

To fold away, depress the small lever and rotate under the PowaFrame where it will bump into position.

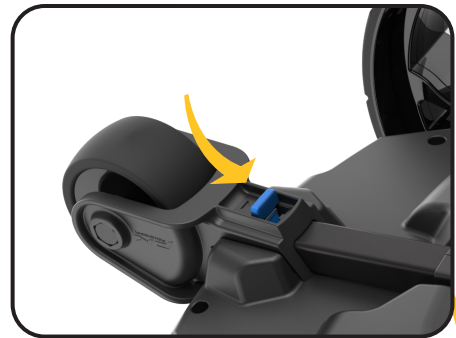

Unfolding the Frame

To open the frame, push the front wheel lever (highlighted blue) towards the bag stay and rotate the front wheel assembly until it locks into place. Secondly, press the main lock button (highlighted blue) and lift the handle until the rear and upper joints click into place.

Reverse the process to fold so that the handle hook locks into the rear joint.



Lithium Battery

IMPORTANT- you must fully charge the battery before using the trolley. Always recharge the battery within 24 hours of use. Failure to do so could reduce the life of the battery. See Section 12 Battery Care, for detailed instructions.

Your Powakaddy trolley features an innovative Plug'n'Play™ battery system including sprung terminals and a locking feature to maintain power connection over uneven terrain. Once your battery is charged and trolley assembled, connect your battery as shown.

1. Engage the front of the battery.
2. Press the rear until the battery clips into position.
3. Press the Power button to turn the trolley on.

To remove the battery, first turn off via the power button. Pull the grey latch to disengage the battery before lifting from the frame.

Note: The Lithium battery can be stored within the tray for transportation. Please ensure you turn off the battery using the power button. Leaving your battery on with the Green LED illuminated could lead to your battery discharging or trolley activating during transportation.



Front Castor Wheel Adjustment

Your trolley is pre-set to run straight but if your trolley is running off course, adjust by:

1. Rotating the front castor wheels 180deg. to expose the two adjustment screws.
2. Release the front wheel lever.
3. Using the hex key provided, adjust the two screws (see below to determine what direction to turn the screws).
4. On the underside of the castor wheel assembly, you can find indicator markings to help align the wheels. Note: moving a wheel a single notch is usually enough to get the trolley running back in a straight line.

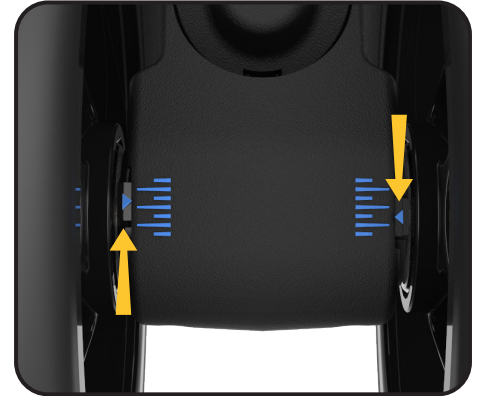
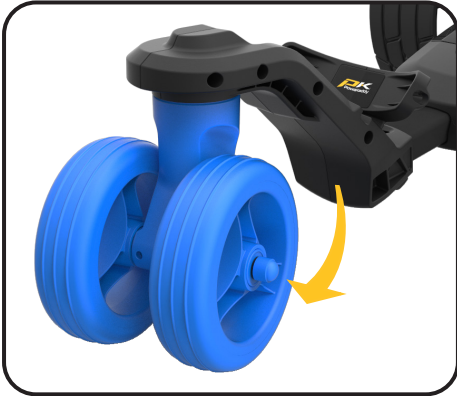

To make the trolley run more towards the LEFT

- Rotate the LH adjustment screw half a turn to the Counter-clockwise.
- Test the trolley running in manual mode with your bag mounted on the trolley.
- If more adjustment is required, rotate the RH adjustment screw half a turn Clockwise.
- Repeat the steps above until your trolley is running straight.



To make the trolley run more toward the RIGHT

- Rotate the RH adjustment screw half a turn to the Counter-clockwise.
- Test the trolley running in manual mode with your bag mounted on the trolley.
- If more adjustment is required, rotate the LH adjustment screw half a turn Clockwise.
- Repeat the steps above until your trolley is running straight.

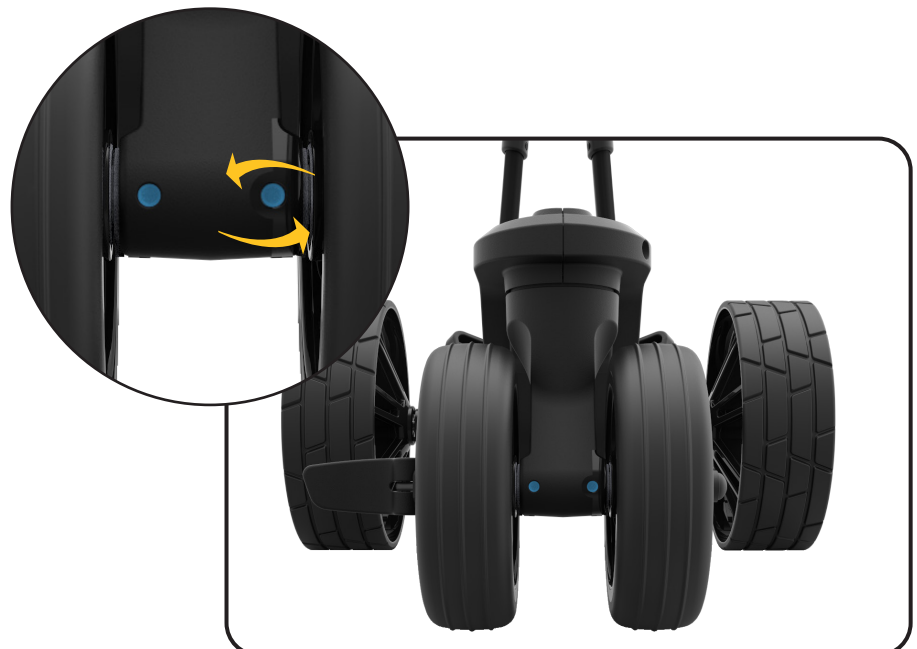

Handle Height Adjust

The handle height is pre-set to suit most users but can be adjusted to one of five positions. To adjust:

1. With the trolley fully open, remove the locking bolt from the height adjust plate using the 4mm hex key supplied in your manual pack.
2. Raise or lower the handle to the new desired position.
3. Tighten the bolt back up ensuring the adjustment plates on both sides are locked into the mating features.



Mag-Lok®

Your trolley is fully compatible with PowaKaddy's innovative, magnetic bag lock system. Quickly and effortlessly attach the bag to the trolley without the need for a lower strap.

The Mag-Lok® is provided with all new compatible PowaKaddy Cart Bags. Remove the Mag-Lok® from the bag and then assemble onto the front bag stay using the screw and 3mm hex key provided.

Don't have a compatible PowaKaddy Cart Bag?
The trolley will still work with most cart bags using the Key-Lok™ system - simply attached the front strap (provided in the carton) by clicking it into place on each side of the lower bagstay.

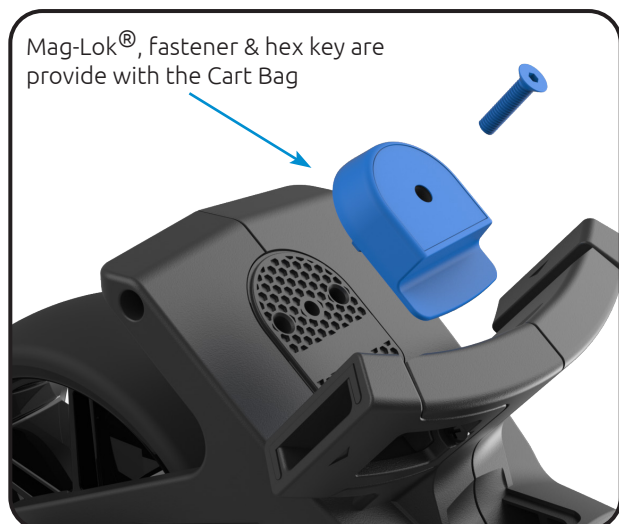

MODES OF OPERATION

Manual Operation

Good for: Tight spaces, car parks, bridges, steep slopes, paths.

- In manual mode the trolley can be fully controlled from the handle, see Manual Controls section for full instruction on handle features.
- Press the centre of the control dial to start the trolley. To increase or decrease the speed rotate the dial.
- The trolleys wheels are free to rotate meaning the trolley can be steered by the user to guide it through tight terrain or in areas where there is risk to people or property.

Note: Due to the front castor wheel, over rough and hill terrain the trolley will naturally steer downhill in manual operation. Please hold onto the trolley handle to remain in full control of the trolley.

Best Practice:

- When operating in tight areas you should physically keep control of the trolley by steering from the handle.
- When travelling up or down steep terrain keep control of the trolley steering the handle.

Remote Operation

Good for: Fairways, around the greens or when you are in the rough.

Not for: Car parks, bridges, paths or negotiating hazards.

- In Remote mode the motors will attempt to drive the trolley in a straight direction. If you try and steer the trolley manually it will counteract your input. Use the remote handset to steer the trolley or use the trolleys control dial to switch to manual mode. The trolley can now be steered manually from the handle.

Best Practice:

- The remote has a nominal 100m range and under certain conditions may travel further. However, it is recommended that you keep the trolley within 25m and a clear line of sight so that you can operate safely and see obstacles in its way.
- Hold the handset in your hand and position the trolley in front of you during operation. Make small adjustments to direction and speed as you see fit. Do not place the handset in your pocket while the trolley is moving.
- Place the handset on the cradle under the handle when taking a shot.
- If you place the handset in your pocket or clip to your belt while taking a shot, use the key lock button to protect from accidental button presses.
- If you are going to walk any distance away from the trolley, keep your handset with you so you can drive the trolley to you instead of walking back to the trolley.





The trolley will switch between control modes based on the last input. For example, if you start the trolley in manual mode then change the direction or speed using the remote the trolley is now in remote mode.

REMOTE HANDSET

Your new remote handset is pre-paired to the trolley and ready to use. The remote can be stowed under the handle when not in use or for charging the remote from the USB-C socket under the handle. To operate by the remote handset, power on the trolley first then power on the remote handset by pressing the power button on the keypad.

Remote Status Indicator

Once connected to the trolley the remote status will be updated on screen the remote status icon is shown in the bottom right side of the display. see status below:

-  1. Remote paired and battery power full
-  2. Remote paired battery power medium
-  3. Remote paired and battery power low
-  4. Remote disconnected

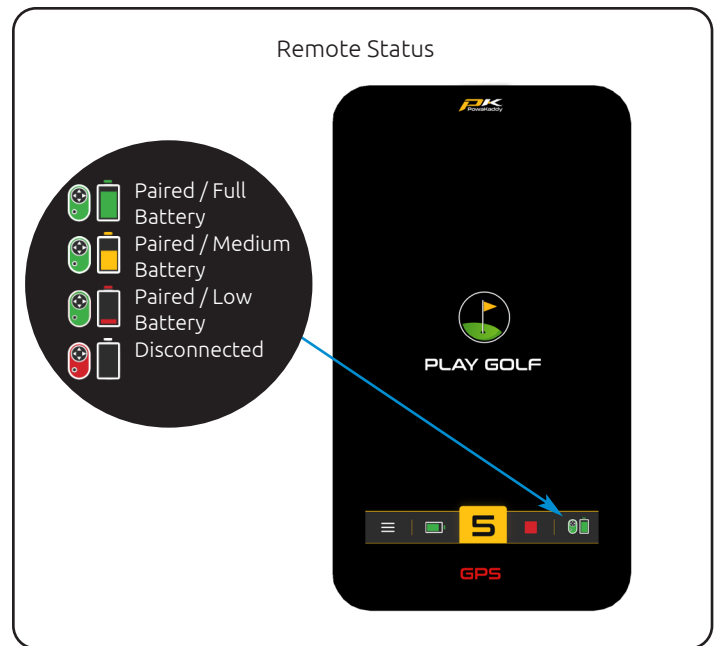

Remote Handset Controls

See the remote control features below for operation of the remote handset:

- POWER BUTTON:**
 - Press to turn handset on. The LED will flash green.
 - Press to lock handset keypad. The LED will flash red. When locked direction button presses will not respond and LED will flash red.
 - Press and Hold to unlock.
- FORWARD ARROW:**
 - Press to move the trolley forward.
 - Press to increase speed.
 - Press and hold for increased acceleration.
- REVERSE ARROW:**
 - Press to decrease speed when trolley moving in a forward direction.
 - Press and Hold to increase the reduction in speed
 - Press and Hold to reverse the trolley.
 - Note: There is no steering function when reversing the trolley. The trolley will stop when the button is released.
- LEFT AND RIGHT ARROWS:**
 - Press and Release quickly when the trolley is moving forwards to make small course corrections.
 - Press for a longer duration when moving forwards to make a larger course correction.
 - Press and Hold when stationary will turn the trolley on the spot.
 - Note: a continuous Press and Hold when the trolley is moving forwards will cause the trolley to make a U-Turn. Once the button has been released, the trolley will continue on its new



heading and accelerate back to the previous speed.

5. STOP BUTTON:

- Press the button to bring the trolley to a glide stop.
- Press and hold to bring to an abrupt emergency stop.

Please note, the remote handset features a sleep function whereby the handset will switch off after 30 minutes of inactivity. To wake up, ensure the trolley is powered on. Press the remote handset power button, the LED will flash green until reconnected to the trolley.

Motor Calibration

The motors of the trolley have been factory calibrated. When operated in remote mode the motor control system automatically adjusts the each wheel speed to maintain the trolley running in a straight line on course. When operated in manual mode this system is disabled for ease of manoeuvrability. If you experience problems with the trolley pulling to the left or right during operation on flat level ground use the following check list before using the calibration steps below:

1. Check the front wheel is rotating freely and not clogged by dirt or debris in between the wheel and wheel housing.
2. Check the front wheel is set to the correct alignment see instructions on adjusting the front wheel.
3. Check the rear wheels are free to move and are correctly engaged with the clutch.
4. Is the golf bag unevenly loaded? Adding more weight to one side could affect the motion of the trolley.

If you have checked these items and are still noticing the trolley pulling off to one side it could be caused by slight difference in the drive performance between left and right. To calibrate the drive speed:

1. Find a large flat area of ground up to 20 metres.
2. Power on the trolley and check the wheels are engaged.
3. Power on the remote handset and check the remote is paired with the trolley.
4. Press and hold the left and right buttons for 5 seconds to start calibration mode. The LED on the remote will flash red and blue to indicate calibration mode active.
5. The trolley motors will start and run the calibration process. The trolley will stop after approx 10m.

Pairing Remote Handset

Your remote handset is already paired to the trolley. If you have to replace a lost or damaged remote handset you will need to pair the Bluetooth remote handset to the trolley. To pair a new remote handset:

1. Power on the trolley first pairing mode is enabled for the first 30 seconds after powering on the Bluetooth device will be set to discovery mode.
2. Power on the remote handset by pressing the power



button.

3. The remote LED will flash green on and off to indicate it is powered on. Press and hold the up and reverse buttons at the same time for over 5 seconds to start pairing mode.
4. The LED on the remote handset will stay on during the button press and then start to flash to indicate the remote handset is set to pairing mode.
5. Once paired with the trolley the LED will stay on for 2 seconds and then turn off. Your trolley is now paired and ready to use.
6. If the LED finishes flashing green on and off and then turns red this indicates the remote has not paired successfully and you will need to repeat the steps above. Power the trolley off and back on to restart the pairing process.

Charging the Handset

Your remote handset can be used for up to 4 rounds of golf on a single charge depending on use and duration. For optimum performance and prolonging the life of the battery, we recommend charging after every use.

If the handset battery starts to run low, a low battery warning LED will flash red on the remote handset. At this point we suggest charging the handset battery using the USB charging port on the handle. The trolley can continue to be used in manual mode.

Using the USB-C cable provided with the trolley connect the remote charging socket in the base of the remote to the trolley USB-C charging socket. You can place the remote securely in the remote dock under handle while charging. To charge the handset:

1. Plug the supplied USB-C cable into a powered USB port on laptop, phone charger or trolley. Always check the manufacturers information before use. (5v/2A max)
 2. Plug in the handset to begin charging.
 3. The LED on the remote will illuminate red to indicate charging.
 4. The charging time will range up to 5 hours depending on the level of discharge.
 5. Once the charging process is complete, the LED will turn to green and charging function will stop.
 6. Unplug the handset once fully charged.
- Please charge the remote using the charging cable supplied. Other cables may cause damage.
 - Avoid leaving the handset plugged in, on charge beyond 5 hours.

USB-C Charging Port

Located on the underside of the handle. Open the hatch to charge GPS & mobile devices. The output is rated up to 5V/2.5A, suitable for most USB devices*

*USB output voltage 5V/2.5A compatible with most USB portable devices, please check device manufacturers instructions before use. PowaKaddy International Ltd accepts no liability for loss of data or damage from using the charging port with incompatible devices.



CONTROLS OVERVIEW

Once your battery is fully charged, connected and powered, your trolley is ready to use.

Note: Your trolley includes a power save mode to extend the life of your battery. After 5 minutes of sitting idle, the trolleys display will turn off. To wake up, press the display or rotate the control dial.

Battery Gauge

Located at the bottom of the display. The charge state of your battery will determine how much of the bar will illuminate.

As you progress through the round the inner bar of the gauge will drop. When the bar has fully extinguished it indicates that the battery is flat. When your battery is new, the bar may only drop a small amount during the entire round. As your battery ages, you may lose more.

If the bar is completely extinguished; (1) you may not have fully charged your battery (2) your battery is nearing the end of its useful life and should be replaced.

Touch Display

Press the display with your finger within the highlighted area, shown right. Touch to operate menus and settings. Use the navigation buttons on screen to toggle between GPS measurement modes. Swipe up and down to navigate settings menus and the scorecard.

Note: you can operate the display in wet weather although keeping the display clear of water will provide the best performance.

Motor Controls

Central Control Dial:

Rotate to adjust the speed of the trolley from 0 to 9. Press to pause and resume the motor at your selected speed.

Power Indicator:

Displays whether power is being applied to the drive system. (Green - ON) (Red - OFF)

Speed Setting:

Rotate the control dial to adjust the speed of the trolley from 0 - 9. Press control dial to start/pause and resume your selected speed.

Note: the motor has a 15-minute time out function and will pause the motor after running continuously for this duration. Press the control dial to resume.

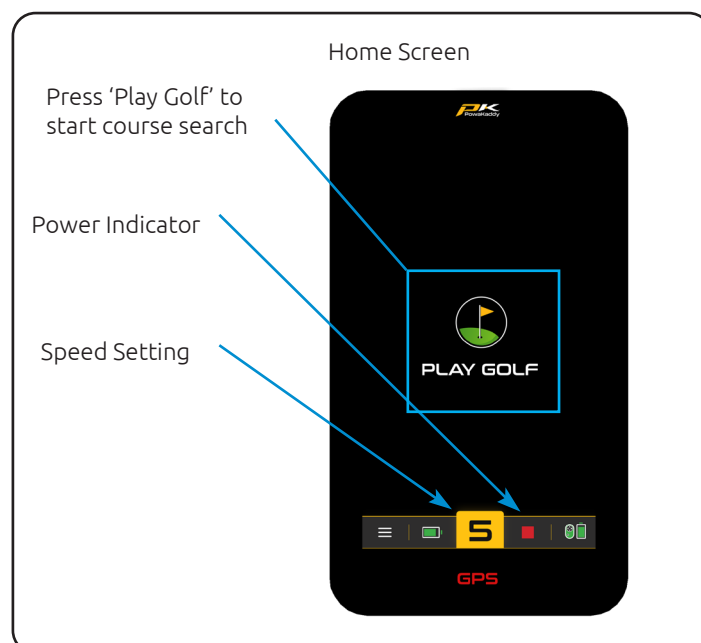
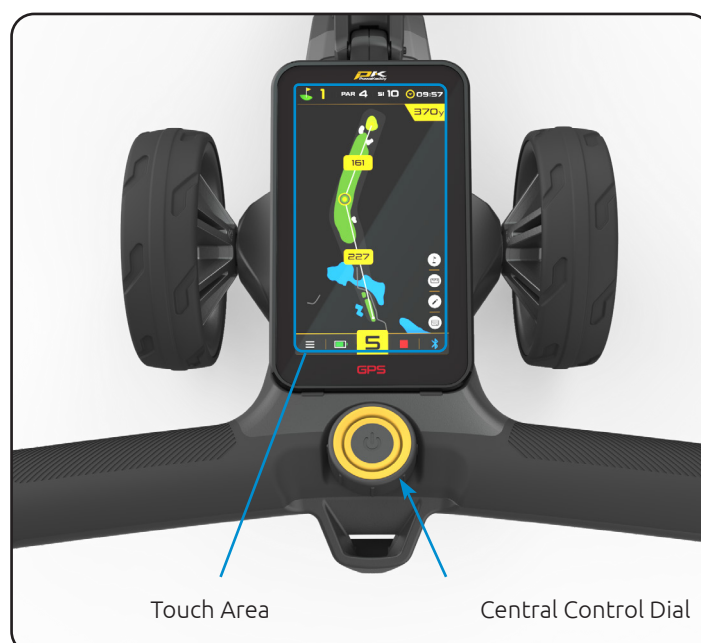
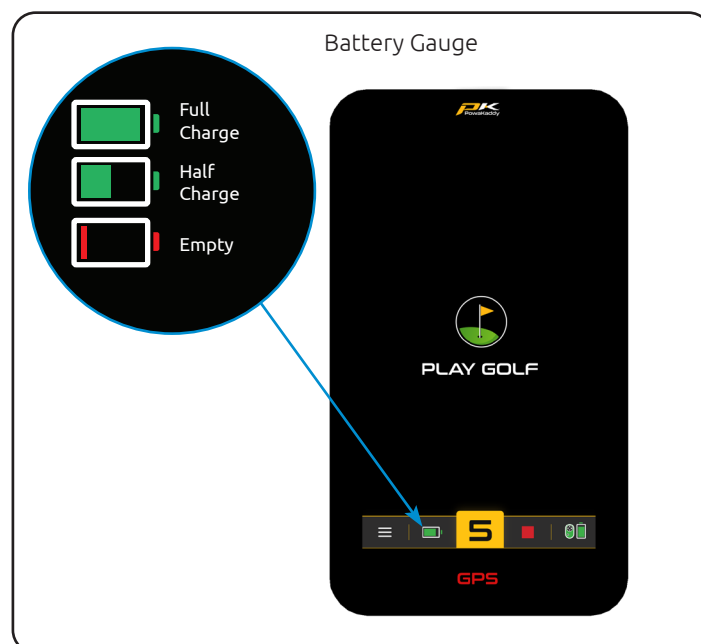

POWAKADDY APP

The all-new PowaKaddy App enables you to activate notifications from your smart device, view scorecards & stats information.

Before connecting your smart device to the trolley ensure the trolley Bluetooth is toggle to the on position.

Pairing

1. Download the free PowaKaddy App from the Google Android Play Store or the App Store for iOS.
2. Open the app and select 'Create Account' button when presented with the login screen (please note, this account is different to the PowaKaddy warranty account).
3. Once the required fields have been populated, select the 'Create Account' button.
4. You must verify your account via the registered email address. Check your Junk folder for this email.
5. Log in to the app using your username (registered email) and password. Your 4 digit verification code provided in the email will be requested.
6. Power the trolley and ensure the Bluetooth is active, turn on/off in the trolley settings menu.
7. Follow the instructions in the app to pair with the trolley. Press the yellow 'Pair' button on the app when prompted.
8. A 6-digit verification code will be displayed on the trolley, select 'Pair' on the trolley and the trolley will automatically share the pairing code with your smart device.

Note: the App QR code will remain on the 'Home screen on the trolley until a mobile device has been paired to the trolley.

Update Software

Your trolley includes over the air (OTA) updates via Wi-Fi for map data and firmware. These are accessed directly from the trolley handle controls. Before use you will need to connect your trolley with your home or club Wi-Fi.

1. Open the trolley settings menu, press settings button bottom left of the screen.
2. Select 'Trolley Settings'.
3. Select Wi-Fi and toggle on to start searching for your home or club Wi-Fi network.
4. Select the required Wi-Fi network and enter the password for the network to connect.
5. Once your trolley is connected to the Wi-Fi you can update maps and keep up to date with the latest updates for your product.

Update Maps

The trolley is pre loaded with the latest map data but this over time may be updated. To update a course map power on the trolley, and open the settings menu. Ensure

Settings Menu - Trolley Settings

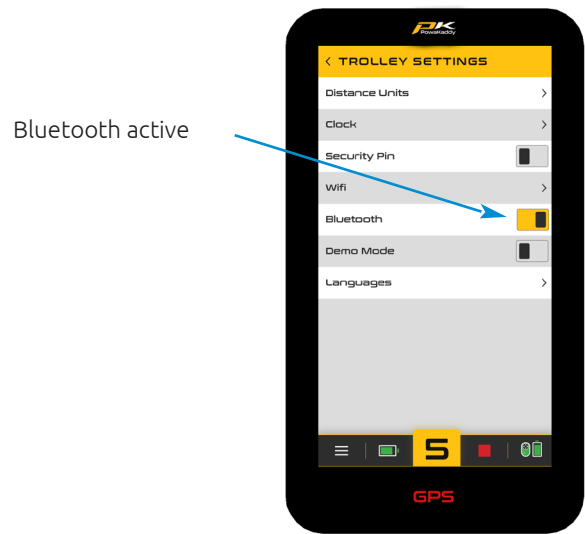

Pairing sequence

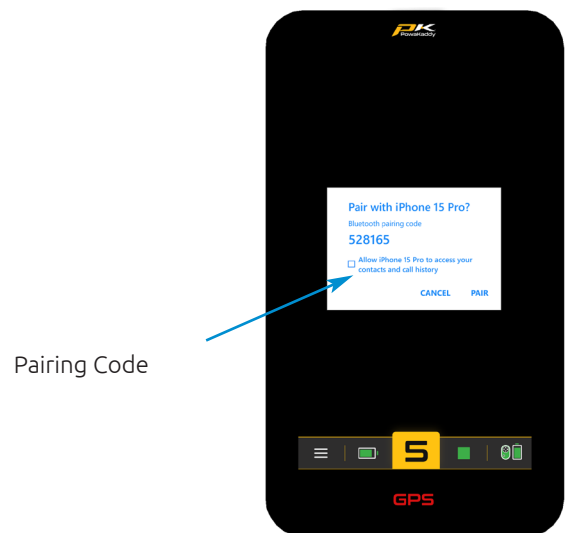

Smart device paired

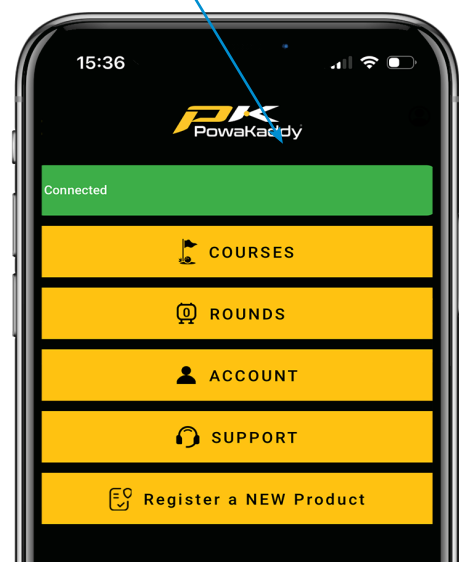

you have the trolley connected to your home or club Wi-Fi network:

1. From the main settings menu select 'Update Course'.
2. Enter part of the course name and press search
3. Identify the correct course name from the list provided.
4. The trolley will download the latest available map data to the device.

Firmware Updates

Critical bug fixes and product enhancements can also be downloaded from the settings menu. Before downloading make sure you have sufficient battery power for the trolley the update can take a few minutes to complete:

1. Open the settings menu and select 'About'
2. Select Check for Updates to search for the latest software release for your product.
3. If an update is available simply press the update button and the latest firmware update will download. This may take a few minutes.

Notifications

Once paired with the PowaKaddy App the trolley can display notifications direct from your smart device including calls, emails and text messages. These must be enabled in the App settings and on the trolley before use. To enable notifications:

1. In the PowaKaddy App, open the 'Support' option.
2. Select 'Notifications' and select the type of notifications you wish to receive.
3. In the trolley settings menu select 'Notifications' toggle grey is off, yellow is on.
4. You will now be able to receive notifications on screen when playing.
5. A pop up display will be shown for each notification.
6. Press Close button to cancel the notification.

Scorecards

To sync your scorecard data to the PowaKaddy App from the trolley, first make sure your smart device and trolley are paired. At the end of your round you must enter the settings menu on the trolley and select 'End Round' and then 'Home' button to save your round data. If not connected, the trolley and app will sync when next paired. We recommend running the App in the background whilst playing.

View the latest scorecard direct from your App dashboard or open the list of saved scorecards via the yellow 'Rounds' button.

- Sort the list by score or the course.
- Review the round stats by pressing the yellow 'Round Stats' button at the bottom of the scorecard.
- Permanently delete a scorecard (and associated stats) by pressing the red 'Bin' button.

Partially completed cards will be synced to the App as long as the end round and home buttons are used before

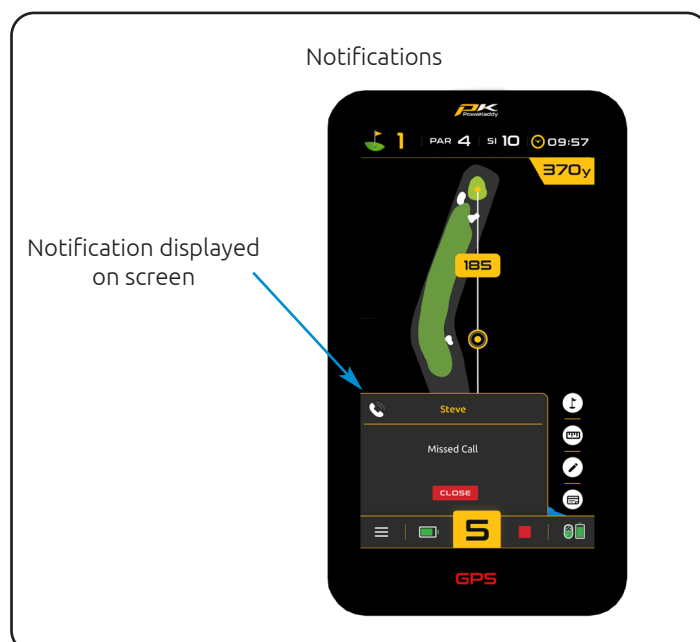
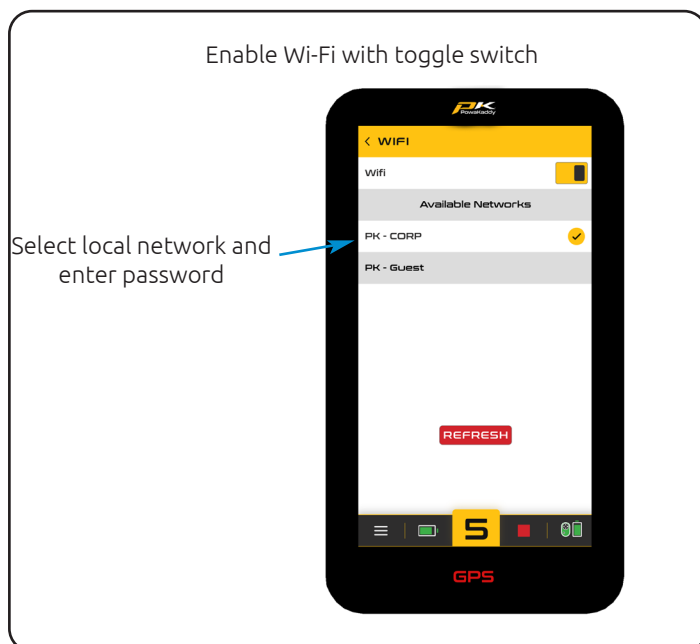
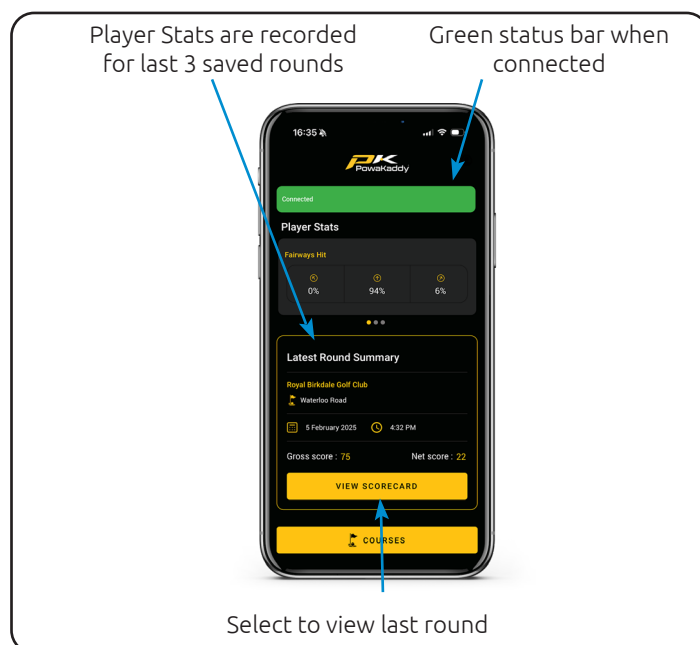

powering down the trolley. The PowaKaddy app will show player stats overview from your last three rounds of golf.

Report a Mapping Error

On your user dashboard on the App, open the 'Support' menu via the yellow button. In the support menu you will find the 'Report Mapping Issue' option.

Search for the course in the list and select it.

- Notify if the GPS distances are showing incorrectly.
- Is the auto-advance working.
- Select specific hole(s) with the error.
- Add further notes.

Press the yellow 'Submit' button to send your report.

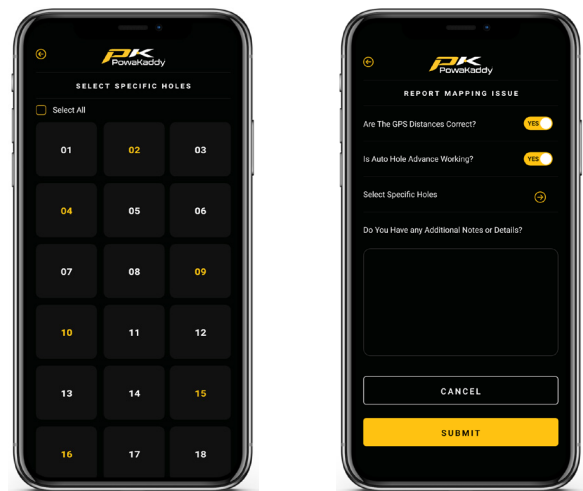
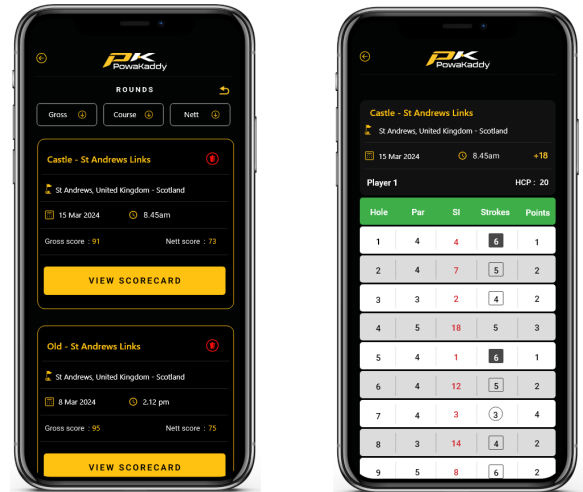

GPS FUNCTIONS

Select a Course

To start using the GPS features, select the 'Play Golf' option from the home screen.

The trolley will start searching for GPS signal. Time taken to gain a lock depends on location and signal strength. For best results, operate away from buildings in an open sky position.

If no signal is acquired after 5 minutes, a Low Signal message will be displayed. Move to a better GPS signal strength area and the trolley will continue searching.

You can operate the motor functions while the GPS device identifies your location. Once the device has a GPS lock a list of local courses will be displayed. Navigate the list by swiping up & down the screen.

Press the desired course from the list. Your selection will

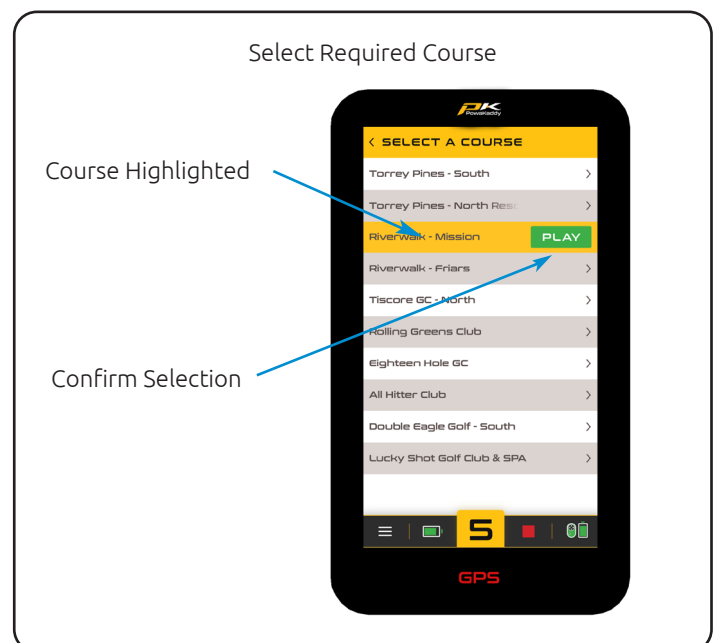

be highlighted, and a green 'Play' button will appear to the right. Press to load the selected course or press another course name to change your selection.

Active Green View

To access the 'Green View', press the button on the right of the screen with the flag icon. This is used to toggle between the full hole view and green view.

The outline of the green for the selected hole is displayed in the centre of the screen. Distances to the Front, Centre and Back of the green are shown at the top of the display. (White and Red dots indicate front & back of the green).

Drop Pin

To move the Pin (represented by the grey dot within the yellow circle), touch a new position on screen to check distance to clear a hazard or marked flag position. Upon release, the pin position and centre distance will update. The drop pin will reset its location when you toggle off of this screen.

Full Hole View

Once you have selected your course the PowaKaddy Default view is the Full Hole View. Toggle between full hole and green view using the button at the right side of the display.

The multi point touch display can be used to move the displayed hole the same as your smart device.

- Single finger touch to move the hole on screen. After 15 seconds the map will snap back to the original position.
- Double tap to zoom in
- Use pinch gesture to zoom in and out

The Full hole view includes a moveable target drop pin with distances to the target and from the target to the green. This feature allows you to plan your approach to the green and avoid any hazards on course. To use the target distances simply:

- Press the centre of the target and drag to the new location. Note the distances shown will update as you move the marker.
- You can combine with the zoom feature to identify any hazards in play and select the right club distance required each time.

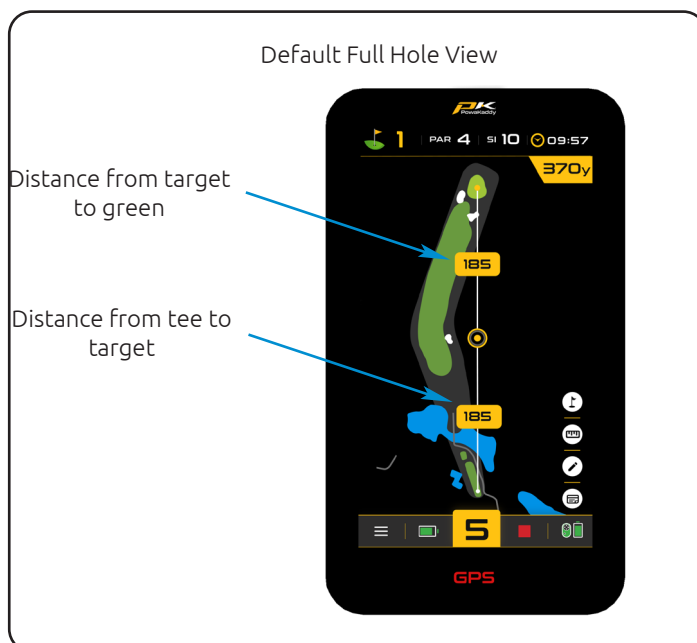
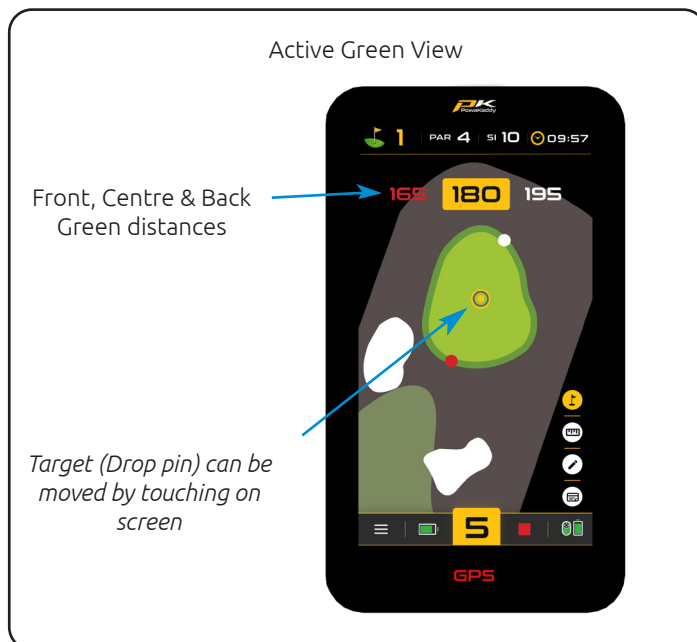

Change Hole

Once the course data has loaded, your trolley will display GPS information for Hole 1. Once you enter the 'tee zone' of the next hole in sequence, the trolley will automatically advance to display information for the next hole.

If you have not entered the mapped 'tee zone', therefore not auto-advancing or you are not starting from the 1st tee; you can select a hole manually. To do so:

1. Press the 'Hole' graphic at the top of the display.
2. A grid displaying holes 1 to 18 is shown. From the grid select the desired hole.

Press required hole number to switch to hole in play

Select Hole

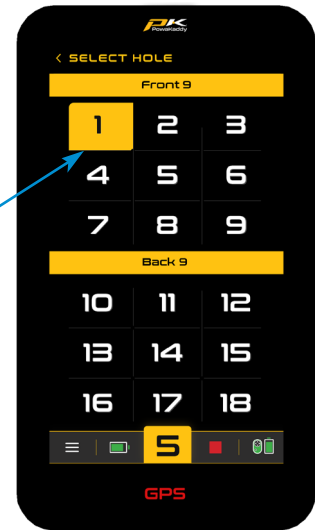

Clock Functions

The Clock, located in the top right corner of the screen displays the current time using GPS data. (Adjust in the Settings menu).

By pressing the Clock, you can toggle through the other two options; the round timer (resets when the round is ended) and lost ball timer.

To activate the lost ball timer:

- Once visible on screen, press and hold on the timer to start and reset the 3-minute timer.
- Once the 3 minutes is up, the Lost Ball Timer icon will flash on the display.

Clock Modes



Shot Distance

To measure a shot:

1. At your starting point press the red 'Reset' button. This will drop a GPS 'pin' and reset the distance to '0'. As you start walking towards your target the display will count.
2. Repeat the above to start a new measurement.

Note, (a) the distance will reset as you advance holes. (b) the measurement will be 'as the crow flies', direct from your start point to your finish point.

Shot Distance

Distance Measured

Reset Button

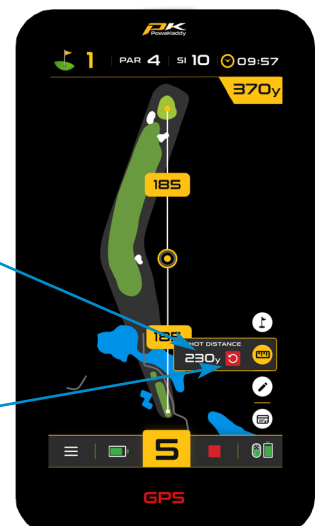

Competition Mode

Activated from the settings menu, for use in competitions where distance features may not be permitted, (see local rules). All distance measuring features will be disabled.

When the trolley is switched off, Competition Mode will automatically disable, re-activating distance features for the next round.

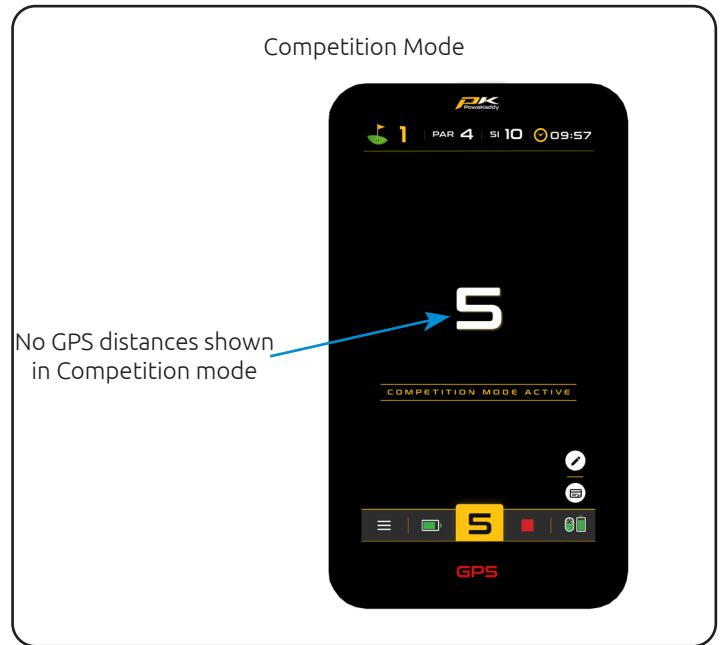

SCORING

Recording Scores

Record your strokes taken on a digital scorecard via the Score screen. The hole in play is shown each time you enter the score screen. Use the arrows to select the hole and to add your strokes.

Press the 'Scorecard' button on the right of the screen to open the full scorecard.

Your entered strokes are populated onto the scorecard. Missed a hole? Press the Add (+) button when viewing the scorecard to open the Score screen for that hole.

Swipe up and down to navigate the scorecard.

Change between Strokeplay and Stableford game modes within the settings menu.

Set your handicap and tee selection (men's or women's) within the settings menu to accurately calculate points and nett scores.

Return to the Score screen via the back arrow in the heading of the Scorecard screen. Any score can be modified within the Score screen at any time.

Statistics

Go beyond just your score. Take the opportunity to record putts taken and fairway hit/missed to build a picture of your game.

Add putts using the up/down arrows. (Note: these are not additional strokes).

Press the Fairway icons to indicate if missed the fairway left, hit the fairway or missed right. The icon will be highlighted yellow when selected. Change or deselect your selection at any time.

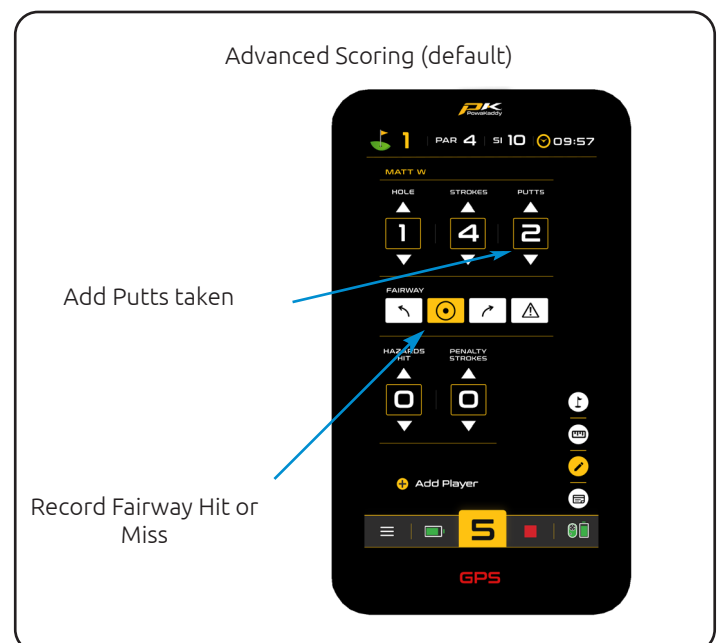
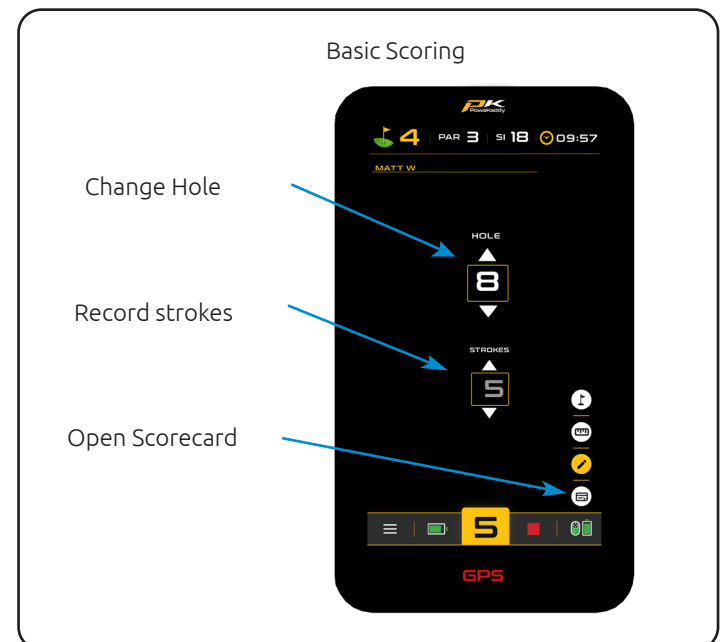

Note: the 'Advanced Scoring' options (Putts & Fairways) can be removed from the Score screen by selecting the 'Basic Scoring' option from the Settings menu.

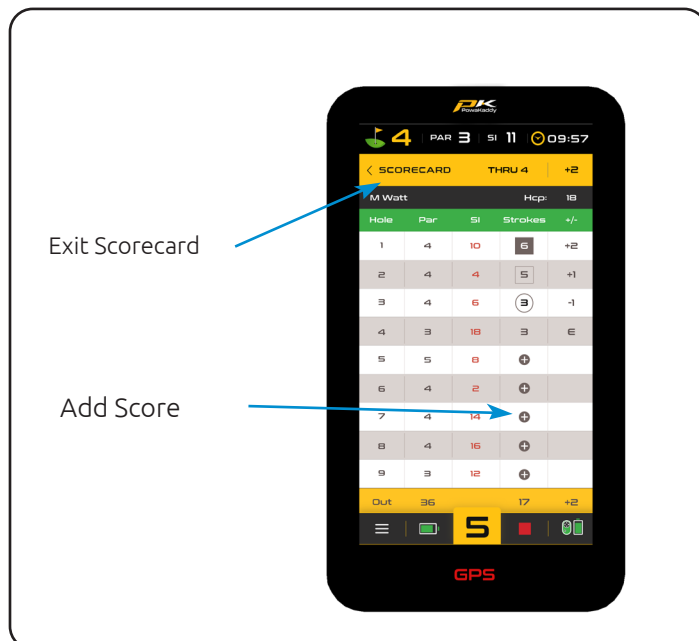

END ROUND

To end your round and save your data:

- Open the Settings menu
- Select the red 'End Round' option. You will be presented with a score summary.
- From here, you can exit back to the GPS screen to continue the round or edit a score, view the round stats; time, trolley distance and advanced stats (if entered using the advanced scoring option). These include greens in regulation (GIR), number of putts, average putts per hole and more.
- If you wish to save your round data, confirm this by pressing the red 'Home' button.

Your completed round and stats will be saved on the trolley and is accessible to view on the App.

Note: your phone must be paired to the trolley (when powered & App open) for the scorecard to sync.

The trolley can store up to 10 rounds. These scorecards will be deleted and replaced unless synced to the App.

We recommend running the App in the background whilst playing.

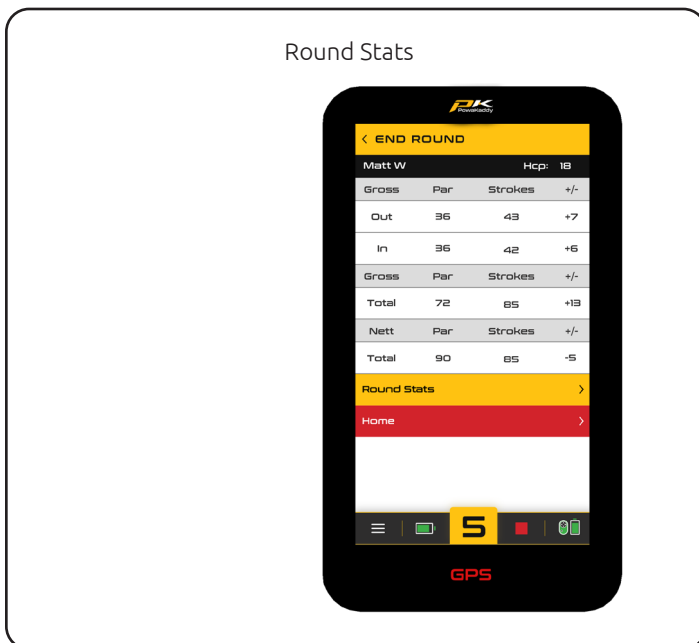
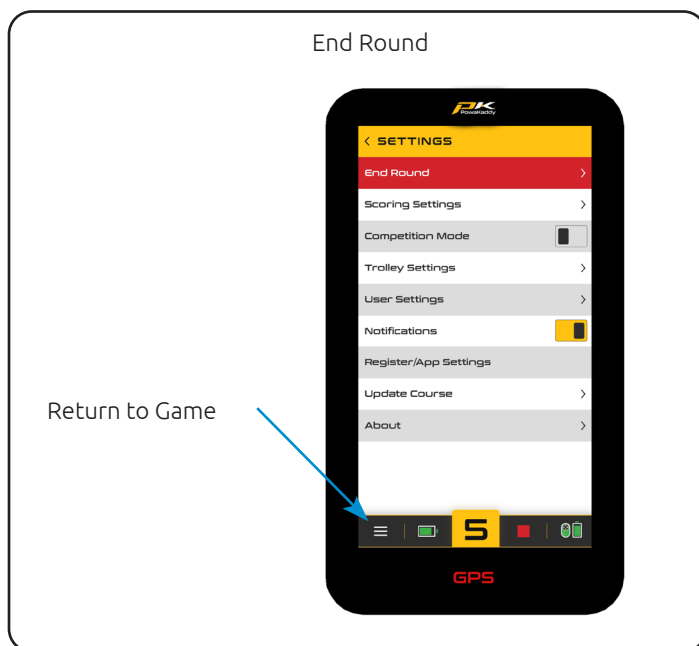

SETTINGS

Access the Settings menu via the icon in the bottom left corner of the display.

Enter sub menu's using the arrows on the right-hand side. Touch a grey toggle switch icon to turn it on; it will turn yellow to indicate it is active. Press again to turn off.

To select an option within a list, simply press it. The yellow tick icon will indicate what selection is active.

The main options you may wish to change are split into two sub menus: 'Score Settings' and 'Trolley Settings'.

Score Settings

- Change game modes between Strokeplay and Stableford.
- Change between Advanced and Basic score entry modes.
- Set your handicap using the keypad.
- Apply a handicap percentage if playing a match (true handicap will be displayed in brackets on the scorecard)
- Change between Men's and Women's Tees.

Trolley Settings

- Change the distance units from yards to metres.
- Adjust the clock and apply daylight saving setting.
- Set a security pin which when active, will be required when the trolley is powered up.
- Turn the Bluetooth on and off.
- Set a different language.
- Turn Demo mode on and off.

Note: A default pin of 7921 is used if ever you forget the set security pin code.

About

The final sub menu is the 'About' screen. Here you will find:

- Trolley firmware versions (When contacting customer service regarding a technical issue, they may request the software versions found here).
- History showing the trolley odometer & run time.
- 'Check for updates'. (Note: the trolley must be paired to the App. Follow instructions on screen and on the App.)

Exit the settings at any time via the icon in the top right-hand corner of the display.

Score Settings

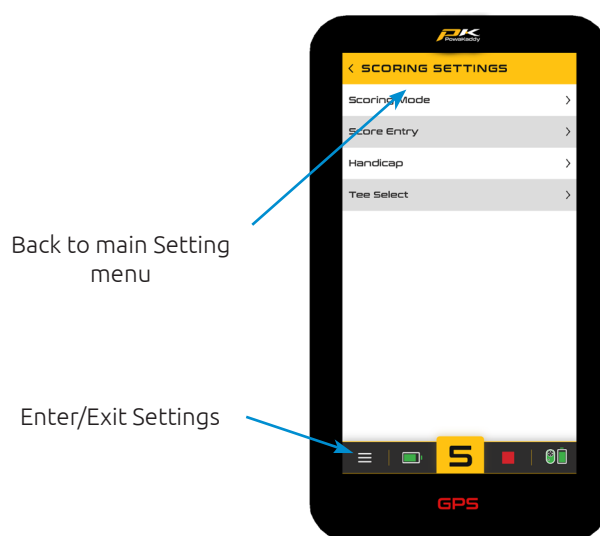

Trolley Settings



About menu

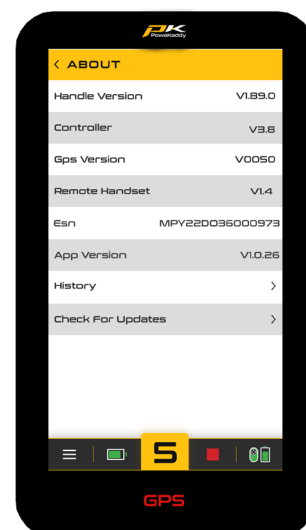

BATTERY CARE

Note: the XL PLUS 30V Lithium Battery is designed for use over 18 holes and must always be fully charged before the next round. Please follow charging instructions as outlined on the following pages. We are aware that some golfers will try to stretch these batteries to 27 holes. This may damage the overall capacity of the battery and may result in an early failure. Playing more than 18 holes with the battery can seriously shorten the battery's life and will invalidate the battery's warranty.

Note: Conditions such as long or exceptionally hilly courses, cold ambient temperatures, wet ground conditions and excessively heavy golf bags will reduce the range of the trolley.

Charging Instructions

1. Plug the charger into the mains - the charger indicator light will be green.
2. Turn on the battery by press and holding the power button until the green light is illuminated.
3. Plug the battery into the charger. The charger light will turn from green to red to indicate the charging process has started.
4. Once the battery is fully charged, the charger status light will be continuous green. At this point, remove the battery from the charger and the charger from the outlet.
5. Turn off the battery using power button.
6. The charging process will take approximately 8 hours depending on the extent of the discharge and battery capacity.
7. Avoid leaving your battery on charge for longer than 12 hours. If left for a long period of time, the battery will automatically turn off.

Please note: if the red and green lights are flashing on the charger, this will indicate that:

- a. The battery was not turned on when connected to the charger.
- b. The charge cycle has finished, and the battery has turned off.
- c. There may be a fault with the battery or charger, please contact PowaKaddy technical support.

Battery Safety

- Never short circuit a battery. Keep it away from paper clips, coins, keys and other small metal objects that can make a connection between the terminals.
- Do not splash or immerse in liquids.
- Do not store or charge the battery in locations where the temperatures may exceed below -10° (14° F) or above 40° C (105° F) such as outdoor sheds or metal buildings in summer.
- Only charge your PowaKaddy battery using the approved charger supplied. Using another charger may damage the battery or cause fire.
- Never use the battery if the casing or terminals are damaged.
- There are no serviceable parts within the battery, DO NOT ATTEMPT TO OPEN THE BATTERY or attempt a repair. RISK OF ELECTRIC SHOCK OR FIRE.
- The battery is a sealed unit. In the unlikely event liquid leaks from the battery, do not touch the liquid as it may cause irritation or burns.

Follow these precautions:

- Skin contact – Wash with soap and water.
 - Inhalation – Expose to fresh air and seek medical advice.
 - Eye contact – Immediately wash with water for at least 15 minutes. Seek medical attention.
 - Disposal – wear gloves to handle the battery and dispose of immediately; contact your local council or recycling centre.
- Do not incinerate the battery even if damaged.
 - Only use a PowaKaddy Battery with a compatible PowaKaddy Trolley. Use of the battery pack on other products may create risk of injury or fire.

Charging Safety

- Do not probe terminals with conductive objects.
- Only charge a PowaKaddy battery using the supplied PowaKaddy charger. The charger and battery pack are specifically designed to work together.
- Only charge on a hard, flat surface.
- The charger will get warm. Do not cover the charger or the battery.
- Do not expose the charger to rain, frost, or snow.
- Do not use a charger if the plug, leads, contacts or casing is damaged.
- Remove the plug with care. Do not pull on the cord.
- Avoid using an extension cable.

Lithium Battery Storage

Batteries are to be stored in a cool and dry place away from direct sunlight and excessive heat or cold; ideally store at room temperature. Charge your battery fully before storing. Charge once every three months thereafter.

Battery Transportation

Ensure the battery is turned off when transporting the trolley to avoid activating the trolley and discharging the battery. Check with your airline before attempting to ship your battery by air.

Lithium Battery Disposal

At the end of its useful life, please discard the battery with due care for the environment.

1. If possible, run down the battery completely and remove from the trolley.
2. Take the battery to your local recycling centre.

MAINTENANCE

Your PowaKaddy trolley is easy to maintain.

1. Store your trolley inside.
2. Never jet wash or immerse in water. Clean the trolley using a sponge and warm water to remove mud, grass, and other debris.
3. Occasionally remove the wheels and apply grease to the axles and wheels.
4. Only use approved PowaKaddy parts for repairs.

Your serial number can be found in the cavity of the rear joint, please make a note for future reference.

Should you experience a problem with your PowaKaddy product, please visit www.powakaddy.com/support



The POWAKADDY name and PK logo are registered trade marks of Powakaddy International Limited and are protected in the UK and other countries and regions. In addition, Powakaddy International Limited owns various design registrations, patents and other IP rights in connection with their products.

Only Powakaddy International Ltd and its authorised stockists and licensees may use the Powakaddy logo, product logos and images in advertising, promotional and sales materials, subject to terms and conditions.

Powakaddy International Ltd is registered in UK. Company No. 07747629, UK Trade Mark Registration No. 3593096



Register now!
Don't miss out!

Scan to open the registration page
or visit: powakaddy.com/my-powakaddy



PGA is a registered trade mark of the Professional Golfers' Association Limited.