



CT8 GPS

OWNERS MANUAL



PGA is a registered trade mark of the Professional Golfers' Association Limited.

POWAKADDY.COM



Thank you for purchasing the all new PowaKaddy. Please read the following instructions carefully. Battery care is very important, please refer to Section 14 for detailed instructions.

When you receive your new PowaKaddy you will have the following:

- | | |
|-------------|------------------------|
| 1 x Trolley | 2 x Wheels |
| 1 x Battery | 1 x Front Bungee Strap |
| 1 x Charger | 1 x Instruction Pack |

CONTENTS

1. Product Warranty	Page 3	7. Scoring	Page 14
2. Safe Use of Product	Page 3	i. Scorecard	
3. Getting Started	Page 4	ii. Statistics	
i. Attaching the Rear Wheels		8. End Round	Page 15
ii. Folding the Frame		9. Settings	Page 15
iii. Lithium Battery		i. Access Settings	
iv. Front Wheel Adjustment		ii. Score Settings	
v. Handle Height Adjustment		iii. Trolley Settings	
vi. Mag-Lok®		iv. About	
4. Controls Overview	Page 7	10. Battery Care	Page 16
i. Battery Gauge		i. Charging Instructions	
ii. Touch Screen		ii. Battery Safety	
iii. Standard Motor Functions		iii. Charging Safety	
iv. Automatic Distance Function (ADF)		iv. Lithium Battery Storage	
v. USB-C Charging Port		v. Lithium Battery Transportation	
vi. Electronic Braking System (EBS)		vi. Lithium Battery Disposal	
5. PowaKaddy App	Page 9	11. Maintenance	Page 18
i. Pairing Instructions			
ii. Map updates			
iii. Advanced Green View			
iv. Report Mapping Error			
v. Scorecard Syncing			
6. GPS Functions	Page 11		
i. Load a Course			
ii. Change Hole			
iii. Clock Functions			
iv. Navigate Distance Functions			
v. Green View			
vi. Drop Pin			
vii. Directional Approach Arrow			
viii. Advanced Green View			
ix. Hazards			
x. Shot Distance			
xi. Competition Mode			
xii. Hazard Abbreviations			

If unable to locate required information within this manual, please visit www.PowaKaddy.com/Support where you will find our trolley product FAQ's. Alternatively contact the PowaKaddy Customer Service team.

PRODUCT WARRANTY



Register now! Don't miss out!

Scan to open the registration page
or visit: powakaddy.com/my-powakaddy

Please take a moment to register your new product.

You will be required to enter the serial numbers for the Trolley, Battery and Charger. These are located on the individual items. The serial number on the trolley is located in the rear joint, see image.

**Terms and conditions apply. See powakaddy.com for details.*



PRODUCT SAFETY

Only use the product as described in this User Manual and the provided Safety Guide.

1. Ensure the trolley is fully assembled before use.
2. This product is for outdoor use only. Do not use in a confined space. Pay particular attention when using in close proximity to other people and vehicles. Take care when using the product in wet or slippery conditions under foot.
3. Use the trolley at a safe and comfortable speed. The higher speed settings are intended for use uphill. Setting the trolley off at high speed may cause the trolley to become unstable.
4. Although weatherproof, avoid driving the trolley through puddles or standing water.
5. This product is not a toy. Take particular care when using around or near children. Children should be supervised if using the product at all times.
6. Never operate the product under the influence of drugs or alcohol.
7. If you are concerned about the operation of your trolley, please contact your local PowaKaddy Service agent or PowaKaddy support.

Note: the trolley is optimised for a bag weight of up to 14kg. An excessively light or heavy bag will affect trolley performance.

For further information, please refer to the Product Safety guide provided with the trolley and visit the PowaKaddy website.

PowaKaddy International Ltd cannot take responsibility for damage or injury caused by improper use.

GETTING STARTED

Attach the Wheels

Remove wheels and frame from the box.

Remove the axle caps and fit the wheels by pressing the release button located on the hub and slide onto the axle until the clutch is engaged. For storage and transit purposes, the wheels can be rotated inwards.

Note: On EBS models only, the wheels can be locked into two positions on the axle; push onto the inner grooves to engage the clutches. The outer grooves can be used when drive is not required.



Unfolding the Frame

To open the frame, push the front wheel lever (highlighted blue) towards the bag stay and rotate the front wheel assembly until it locks into place. Secondly, press the main lock button (highlighted blue) and lift the handle until the rear and upper joints click into place.

Reverse the process to fold so that the handle hook locks into the rear joint.



Lithium Battery

IMPORTANT- you must fully charge the battery before using the trolley. Always recharge the battery within 24 hours of use. Failure to do so could reduce the life of the battery. See the Battery Care section, for detailed instructions.

Your PowaKaddy trolley features an innovative Plug'n'Play™ battery system including sprung terminals and a locking feature to maintain power connection over uneven terrain. Once your battery is charged and trolley assembled, connect your battery as shown.

1. Engage the front of the battery.
2. Press the rear until the battery clips into position.
3. Press the Power button to turn the trolley on.

To remove the battery, first turn off via the power button. Pull the grey latch to disengage the battery before lifting from the frame.

Note: The Lithium battery can be stored within the tray for transportation. Please ensure you turn off the battery using the power button. Leaving your battery on with the Green LED illuminated could lead to your battery discharging or trolley activating during transportation.



Front Wheel Adjust

To modify the straight line running of the trolley :

1. Release the front wheel lever.
2. Rotate the adjustment wheel up to make your trolley track more to the LEFT.
3. Rotate the adjustment wheel down to track more to the RIGHT.
4. Once you are happy the trolley is running straight re-apply the lever to lock in position.

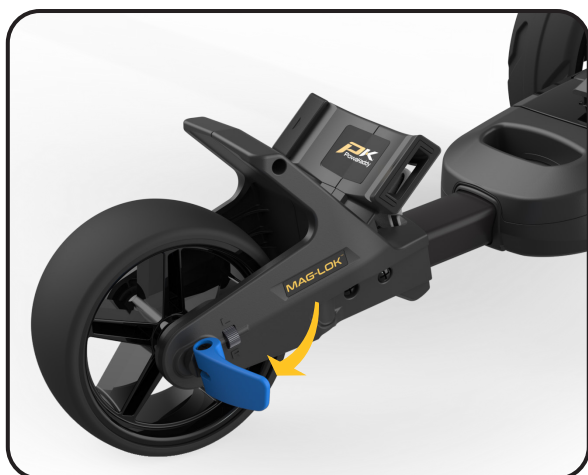

Handle Height Adjust

The handle height is pre-set to suit most users but can be adjusted to one of five positions. To adjust:

1. With the trolley fully open, remove the locking bolt from the height adjust plate using the 4mm hex key supplied in your manual pack.
2. Raise or lower the handle to the new desired position.
3. Tighten the bolt back up ensuring the adjustment plates on both sides are locked into the mating features.



Mag-Lok®

Your trolley is fully compatible with PowaKaddy's innovative, magnetic bag lock system. Quickly and effortlessly attach the bag to the trolley without the need for a lower strap.

The Mag-Lok® is provided with all new compatible PowaKaddy Cart Bags. Remove the Mag-Lok® from the tag and then assemble onto the front bag stay using the screw and 3mm hex key provided.

Don't have a compatible PowaKaddy Cart Bag?
The trolley will still work with most cart bags using the Key-Lok™ system - simply attached the front strap (provided in the carton) by clicking it into place on each side of the lower bagstay.

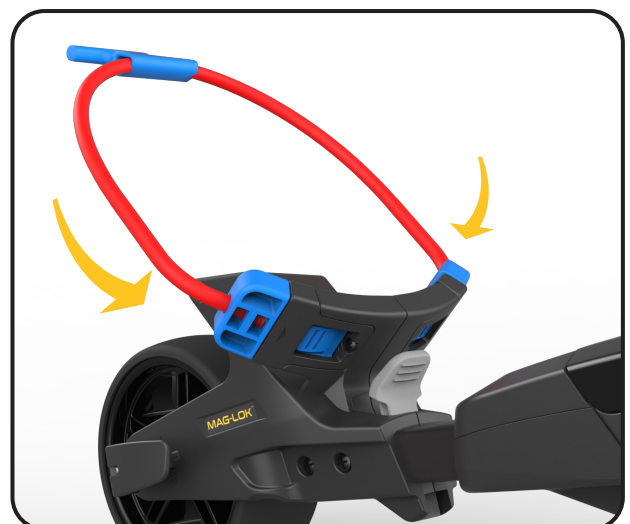
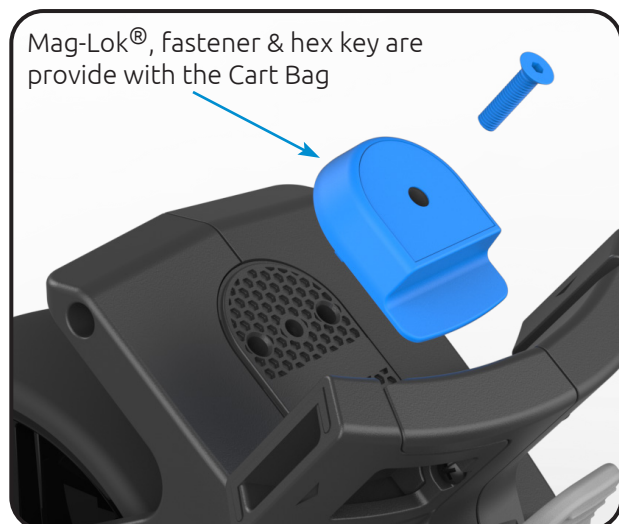

CONTROLS OVERVIEW

Once your battery is fully charged, connected and powered, your trolley is ready to use.

Note: Your trolley includes a power save mode to extend the life of your battery. After 5 minutes of sitting idle, the trolleys display will turn off. To wake up, press the display or rotate the control dial.

Battery Gauge

Located on the left side of the display. The charge state of your battery will determine how much of the bar will illuminate.

As you progress through the round the inner bar of the gauge will drop. When the bar has fully extinguished it indicates that the battery is flat. When your battery is new, the bar may only drop a small amount during the entire round. As your battery ages, you may lose more.

If the bar is completely extinguished; (1) you may not have fully charged your battery (2) your battery is nearing the end of its useful life and should be replaced.

Touch Display

Press the display with your finger within the highlighted area, shown right. Touch to operate menus and settings. Swipe left and right to toggle between GPS measurement modes. Swipe up and down to navigate menus and the scorecard.

Note: you can operate the display in wet weather although keeping the display clear of water will provide the best performance.

Motor Controls

Central Control Dial:

Rotate to adjust the speed of the trolley from 0 to 9. Press to pause and resume the motor at your selected speed.

Power Indicator:

Displays whether power is being applied to the drive system. (Green - ON) (Red - OFF)

Speed Setting:

Rotate the control dial to adjust the speed of the trolley from 0 - 9. Press control dial to start/pause and resume your selected speed.

Note: the motor has a 15-minute time out function and will pause the motor after running continuously for this duration. Press the control dial to resume.

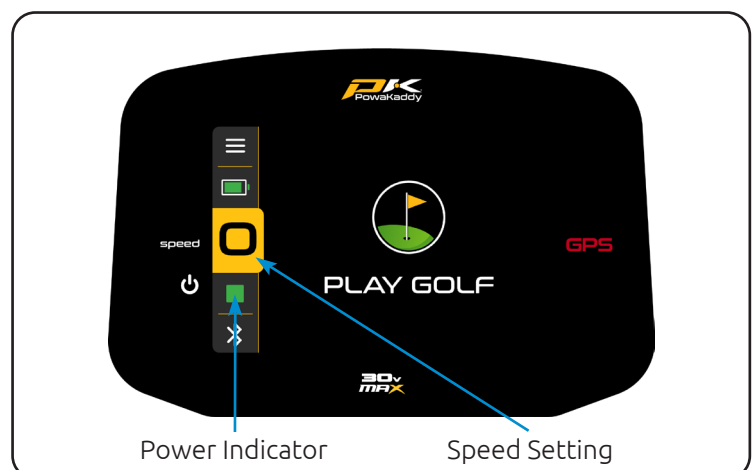
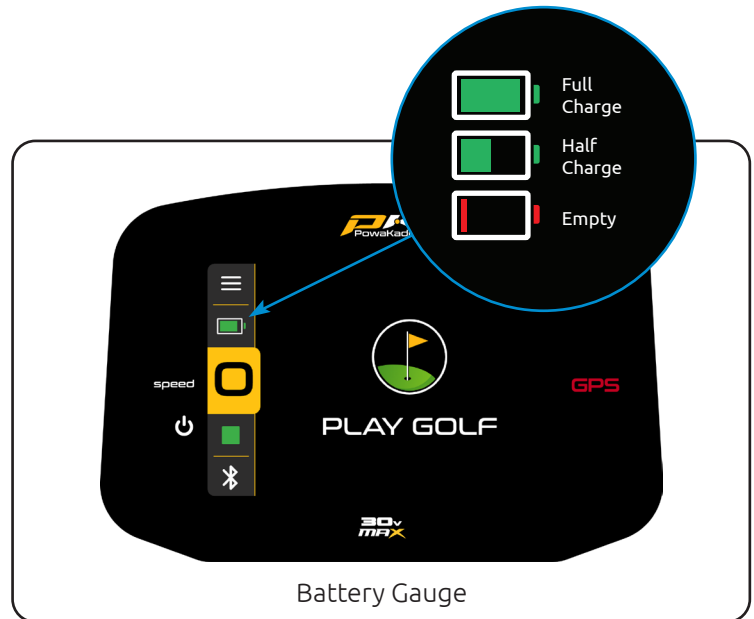

ADF (Automatic Distance Function)

Available on the Play golf screens; Green View, Hazard, Shot Distance and Score. The ADF function is a convenient way of sending your trolley a set distance up to 50 yards/metres, for example, when you are approaching a green you can send the trolley towards the next tee if the route allows. Note: it is not recommended to send your trolley unattended over steep or rough terrain.

To activate ADF the motor must be paused and then:

1. Press and hold the control dial until ADF display (left) appears on the screen.
2. Rotate the control dial to select the distance between 5 and 50 (yards/metres).
3. To set the trolley in motion, press the control dial to start the motor. The trolley will run by default at speed 4.

To cancel the ADF during set-up, rotate the control dial anti-clockwise so "0" is displayed and confirm by pressing the control dial or alternatively, press the red 'Cancel' button.

To cancel when the trolley is in motion, simply press the control dial to pause the motor as you would during normal use or alternatively, press the red 'Cancel' button.

Note: ADF distances are approximate based on flat level terrain conditions using a fully charged battery. The overall distance may be affected by terrain conditions, obstacles or incline based on battery power and the weight.

USB-C Charging Port

Located on the underside of the handle. Open the hatch to charge GPS & mobile devices. The output is rated up to 5V/2.5A, suitable for most USB devices*

*USB output voltage 5V/2.5A compatible with most USB portable devices, please check device manufacturers instructions before use. PowaKaddy International Ltd accepts no liability for loss of data or damage from using the charging port with incompatible devices.

EBS (Electronic Braking System)

The optional extra EBS is an automatic assisted braking system for downhill descents, maintaining the selected speed to prevent the trolley running away from the user.

Warning: EBS is an assisted braking system for hill descent, not a 100% parking brake. The trolley must be powered on and the wheels engaged with the clutch for the braking system to function.

Caution: Steep, wet or loose ground conditions may cause the wheels to lock and slip. When walking up, down or traversing slopes, please maintain a firm grip on the handle to assist the trolley and avoid injury or damage.

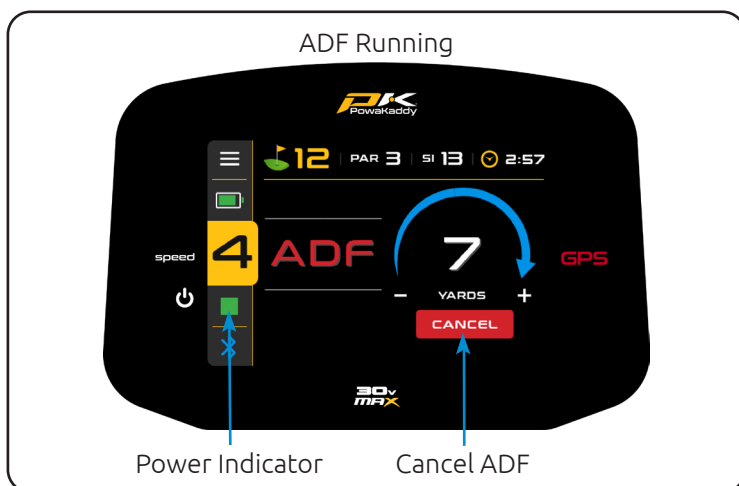
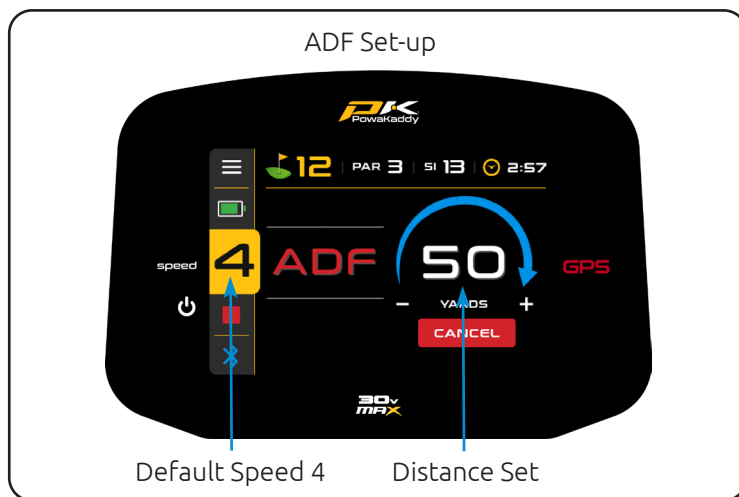

POWAKADDY APP

The all-new PowaKaddy App enables you to update map data, add hazards to the advanced green view of your favourite courses, update your trolley software and view scorecards & stats.

The Bluetooth status is indicated in the bottom left-hand corner of the display.

- Red = Bluetooth turned off
- White = Bluetooth turned on
- Blue = Bluetooth paired to device

Pairing

1. Download the free PowaKaddy App from the Google Play Store or the Apple App Store.
2. Open the app and select the yellow 'Create Account' button when presented with the login screen (please note, this account is different to the PowaKaddy warranty account).
3. Once the required fields have been populated, select the yellow 'Create Account' button.
4. Verify your account via the registered email address.
5. Log in to the app using your username (registered email) and password.
6. Power the trolley and ensure the Bluetooth is active – the Bluetooth icon in the bottom right-hand corner should be white (turn on/off in the settings menu).
7. Press the yellow 'Pair' button on the app.
8. A 6-digit verification code will be displayed on the trolley, enter this into the app.

Note: the App QR code will remain on the 'Home screen on the trolley until a mobile device has been paired to the trolley.

Update Software

When paired, your trolleys status will be displayed at the top of the App screen. Within the green bar, next to your battery status, a notification will be displayed if an update is available for your trolley. To update:

1. Press the green bar.
2. Click the yellow 'Next' button.
3. The update will begin.

The update will take a few minutes to complete. A status will be displayed on the trolley screen. During the update:

- Keep the mobile device in close proximity to the trolley to maintain Bluetooth connection.
- Do not close the app, the update will be aborted.
- Do not turn the trolley off.

Note: a software update can only be initiated outside of the 'Play Golf' mode. We suggest updating the software only with the 'Home screen displayed on the trolley. Once the update is complete, please restart the trolley.

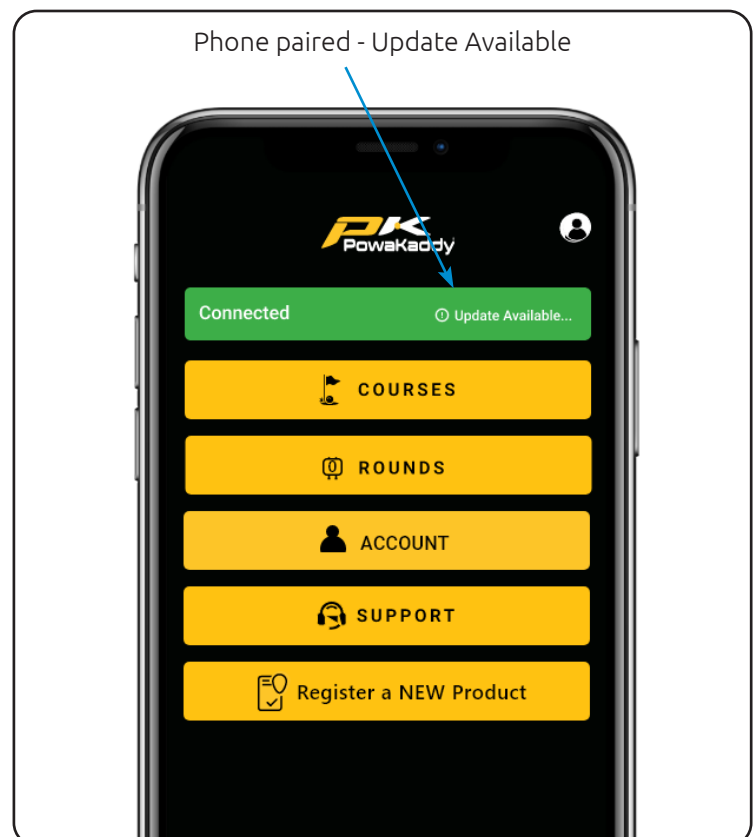
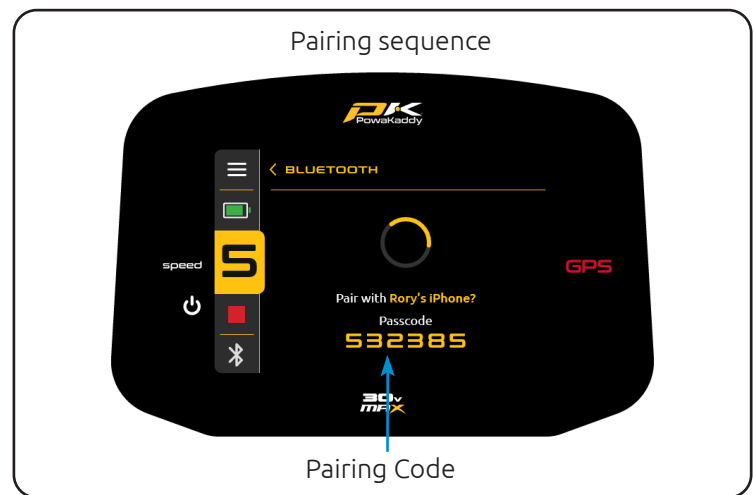
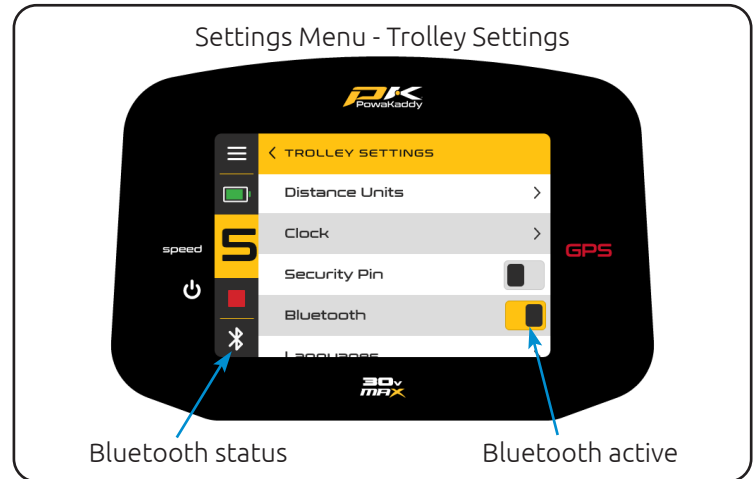

If for any reason the update fails, the trolley will maintain its current software version & settings. Simply re-initiate the update, following the steps above.

Update Maps

The trolley is shipped with the latest map data but this over time may be updated. To report a course change – see below.

To update a course map on the trolley, with the trolley powered and mobile device paired:

1. Select the yellow 'Courses' button from your user dashboard on the App.
2. Select a course from the list (sorted by location or search for a course).
3. Press the yellow 'Done' button once the update has been completed. (The update should take just a few seconds).

Note: a software update can only be initiated outside of the 'Play Golf' mode. We suggest updating the software only with the 'Home screen displayed on the trolley.

Advanced Green View

Add hazards and bunkers to your green view using the app. This data will be saved to the trolley until removed.

1. Select the yellow 'Course' button from your user dashboard on the App.
2. Select the Advanced Green Display tab to the right-hand side.
3. Search for a course via the search bar and press the yellow button so start the data transfer.
4. Press the yellow 'Done' button once the update has been completed. (The update will take a matter of seconds).

Please note: a maximum of 20 courses on the trolley can display the Advanced Green View bunkers and hazards at one time – a pop-up on the app will inform you if you have exceeded the limit.

Remove the Advanced Green View bunkers and hazards by pressing the red bin icon.

Note: the mapping for these hazards may change overtime. Remove and re-install the advanced map to refresh the data on the trolley.

Report a Mapping Error

On your user dashboard on the App, open the 'Support' menu via the yellow button. In the support menu you will find the 'Report Mapping Issue' option.

Search for the course in the list and select it.

- Notify if the GPS distances are showing incorrectly.
- Is the auto-advance working.
- Select specific hole(s) with the error.
- Add further notes.

Press the yellow 'Submit' button to send your report.

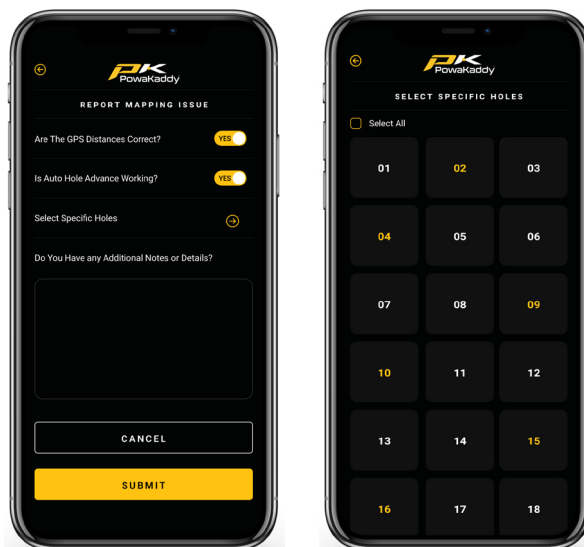
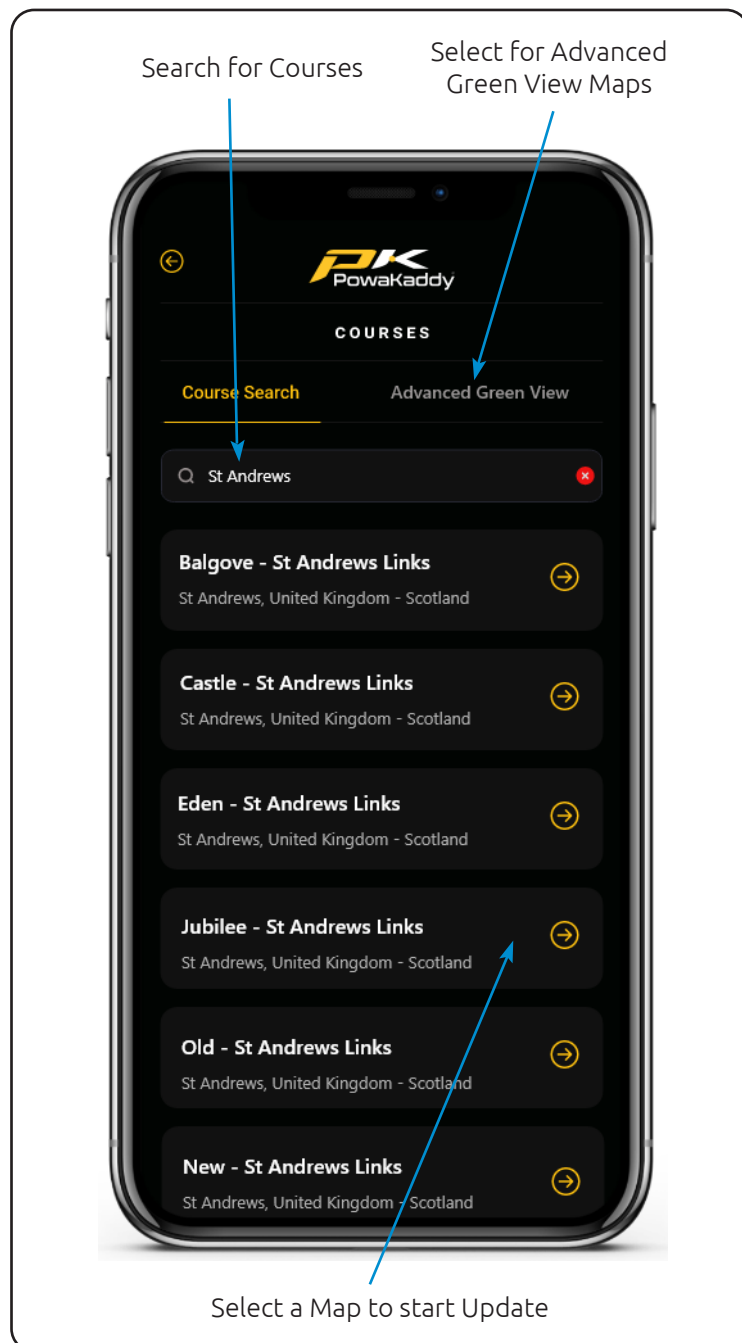

Scorecards

To sync the scorecard data to the App from the trolley when the two devices are paired, simply enter the settings and select 'End Round' & 'Home'. If not connected, the trolley and app will sync when next connected. We recommend running the App in the background whilst playing.

View the latest scorecard direct from your App dashboard or open the list of saved scorecards via the yellow 'Rounds' button.

- Sort the list by score or the course.
- Review the round stats by pressing the yellow 'Round Stats' button at the bottom of the scorecard.
- Permanently delete a scorecard (and associated stats) by pressing the red 'Bin' button.

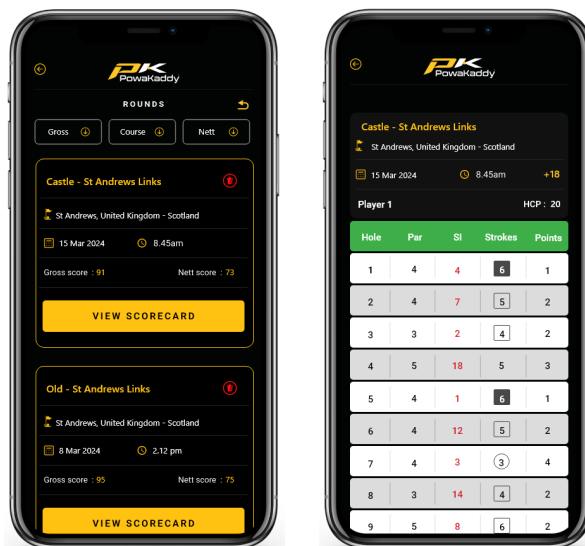

Partially completed cards will be synced to the App as long as the round has been ended on the trolley. Deleted any unwanted cards using the 'Bin' button.

GPS FUNCTIONS

Select a Course

To start using the GPS features, select the 'Play Golf' option from the home screen.

The trolley will start searching for GPS signal. Time taken to gain a lock depends on location and signal strength. For best results, operate away from buildings in an open sky position.

If no signal is acquired after 5 minutes, a Low Signal message will be displayed. Move to a better GPS signal strength area and the trolley will continue searching.

You can operate the motor functions while the GPS device identifies your location. Once the device has a GPS lock a list of local courses will be displayed. Navigate the list by swiping up & down the screen.

Press the desired course from the list. Your selection will be highlighted, and a green 'Play' button will appear to the right. Press this to load the selected course or press another course name to change your selection.

Change Hole

Once the course data has loaded, your trolley will display GPS information for Hole 1. Once you enter the 'tee zone' of the next hole in sequence, the trolley will automatically advance to display information for the next hole.

If you have not entered the mapped 'tee zone', therefore not auto-advancing or you are not starting from the 1st tee; you can select a hole manually. To do so:

1. Press the 'Hole' graphic at the top of the display.
2. A grid displaying holes 1 to 18 is shown. From the grid select the desired hole.

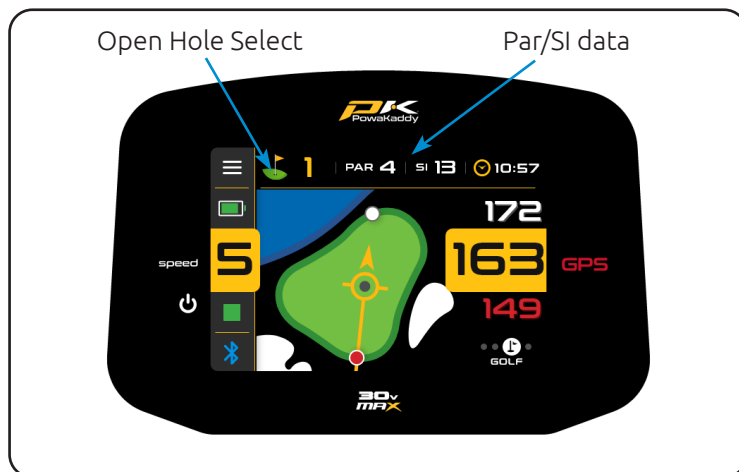
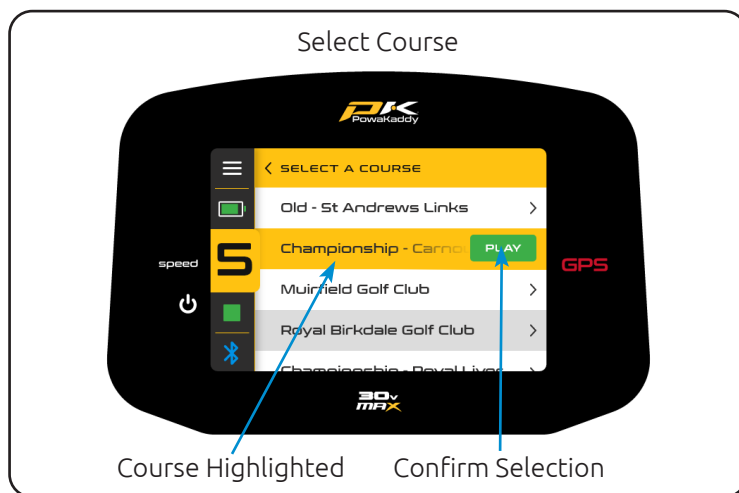

Clock Functions

The Clock, located in the top right corner of the screen displays the current time using GPS data. (Adjust in the Settings menu).

By pressing the Clock, you can toggle through the other two options; the round timer (resets when the round is ended) and lost ball timer.

To activate the lost ball timer:

- Once visible on screen, press and hold on the timer to start and reset the 3-minute timer.
- Once the 3 minutes is up, the Lost Ball Timer icon will flash on the display.

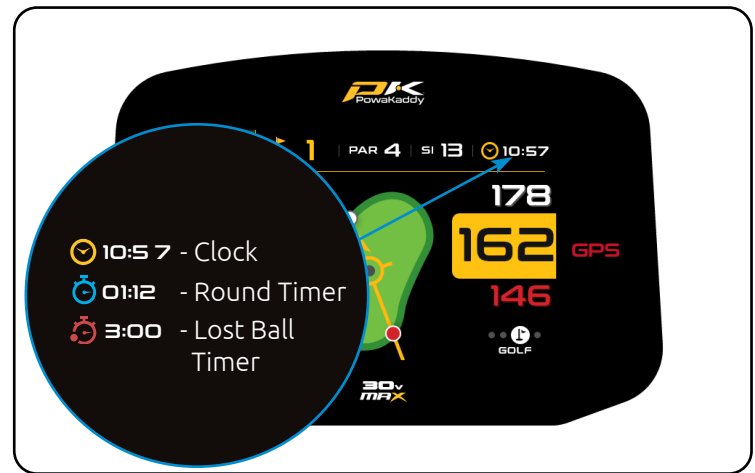

Navigate Distance Functions

Swipe across the screen from right to left to navigate between the Active Green View, Hazard display, Distance Measure (and finally the Score screen).
Swipe a fourth time to loop back to the Active Green View screen.

Swipe left to right to toggle back through the previous displays.



Active Green View

The outline of the green for the selected hole is displayed in the centre of the screen. Distances to the Front, Centre and Back of the green are shown on the right-hand side of the display. (White and Red dots indicate front & back of the green).

Drop Pin

To move the Pin (represented by the grey dot within the yellow arrow circle), touch a new position within the outline of the green. Upon release, the pin position and centre distance will update.

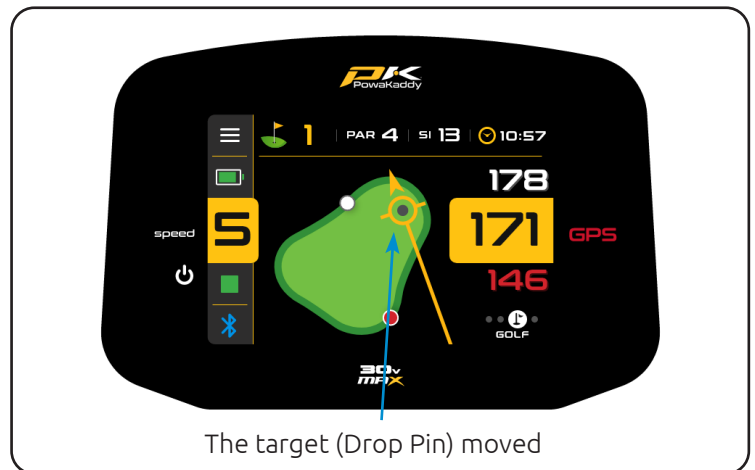

Directional Approach Arrow

Use the directional arrow to avoid hitting over hazards. The arrow originates at your trolleys location and update based on the pin position (Drop Pin).

Advanced Green View

Update your map data via the PowaKaddy App (Page 10) to add surrounding hazards and bunkers to the green view. Note, the Drop Pin can be moved off the green to give you precise carry distances over hazards.

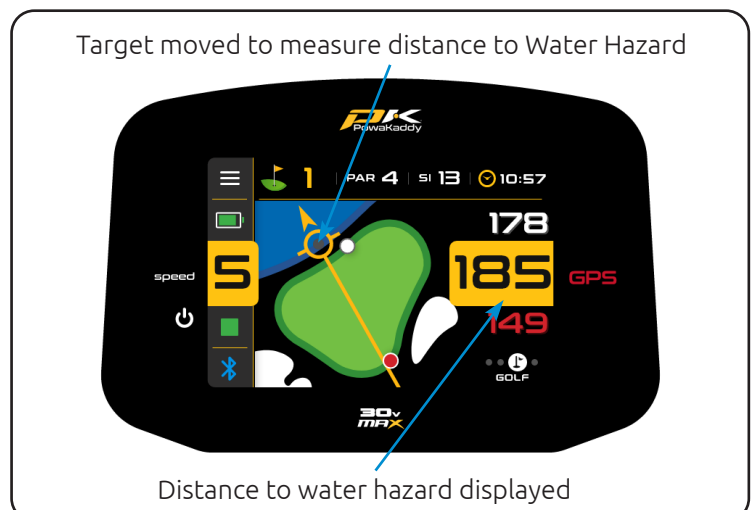

Hazards

A maximum of 4 hazards are mapped on each hole. As you pass the hazard it is removed from the screen. Three categories of hazards are mapped: Bunkers, Water hazards and End of Fairways. These are depicted using 3 different symbols.

The measurement displayed for each hazard can be to the front, middle or back of the hazard depending on the description i.e. CRKC - Creek Carry. (See the Hazard abbreviations below for all Hazard types).

Note: for convenience the distance to the pin on the is displayed at the bottom of the display and will update with changes to the pin position (Drop Pin).

Shot Distance

To measure a shot:

1. At your starting point press the red 'Reset' button. This will drop a GPS 'pin' and reset the distance to '0'. As you start walking towards you target the display will count.
2. Repeat the above to start a new measurement.

Note, (a) the distance will reset as you advance holes. (b) the measurement will be 'as the crow flies', direct from your start point to your finish point.



Competition Mode

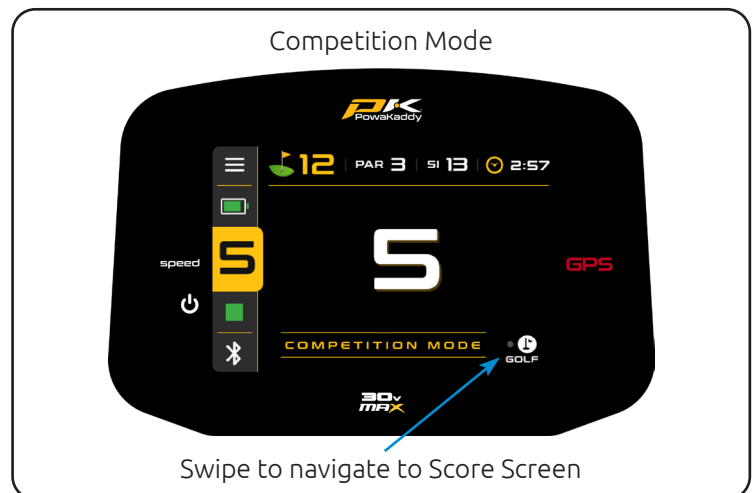
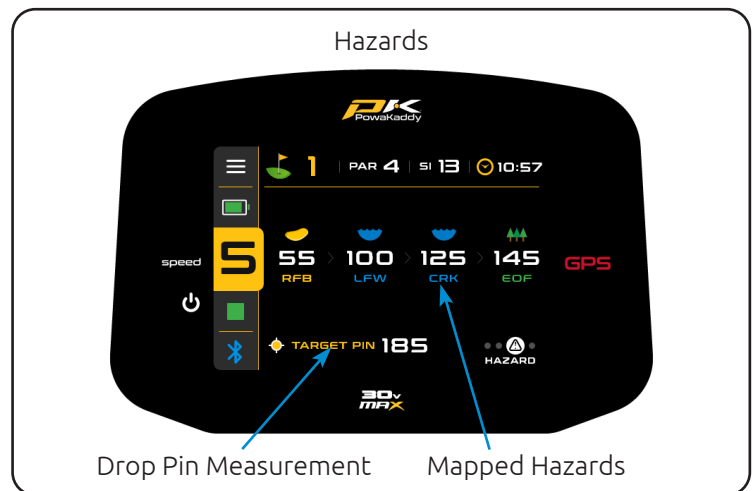
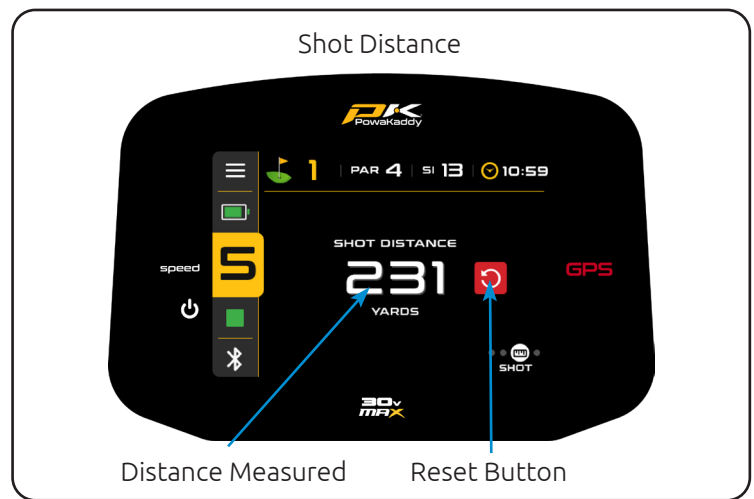

Activated from the settings menu, for use in competitions where distance features may not be permitted, (see local rules). All distance measuring features will be disabled including ADF.

When the trolley is switched off, Competition Mode will automatically disable, re-activating distance features for the next round.





Hazard Abbreviations



 **LFB** Left Fairway Bunker
 **MFB** Middle Fairway Bunker
 **RFB** Right Fairway Bunker

 **LFWC** Left Fairway Water Carry
 **MFWC** Middle Fairway Water Carry
 **RFWC** Right Fairway Water Carry

 **LFW** Left Fairway Water
 **MFW** Middle Fairway Water
 **RFW** Right Fairway Water

 **CRK** Creek
 **CRKC** Creek Carry
 **EOF** End of Fairway (Usually Doglegs)

 **LGB** Left Green Bunker
 **RGB** Right Green Bunker
 **FGB** Front Green Bunker
 **BGB** Back Green Bunker

 **LGW** Left Green Water
 **RGW** Right Green Water
 **FGW** Front Green Water
 **BGW** Back Green Water

SCORING

Recording Scores

Record your strokes taken on a digital scorecard via the Score screen using the up/down arrows.

Press the green 'Scorecard' icon in the top right-hand corner of the display to open the full scorecard.

Your inputted strokes are populated onto the scorecard. Missed a hole? Press the Add (+) button to open the Score screen for that hole.

Swipe up and down to navigate the scorecard.

Change between Strokeplay and Stableford game modes within the settings menu.

Set your handicap and tee selection (men's or women's) within the settings menu to accurately calculate points and nett scores.

Return to the Score screen via the back arrow in the heading of the Scorecard screen. Any score can be modified within the Score screen at any time.

Statistics

Go beyond just your score. Take the opportunity to record putts taken and fairway hit/missed to build a picture of your game.

Add putts using the up/down arrows. (Note: these are not additional strokes).

Press the Fairway icons to indicate if missed the fairway left, hit the fairway or missed right. The icon will be highlighted yellow when selected. Change or deselect your selection at any time.

Note: the 'Advanced Scoring' options (Putts & Fairways) can be removed from the Score screen by selecting the 'Basic Scoring' option from the Settings menu.

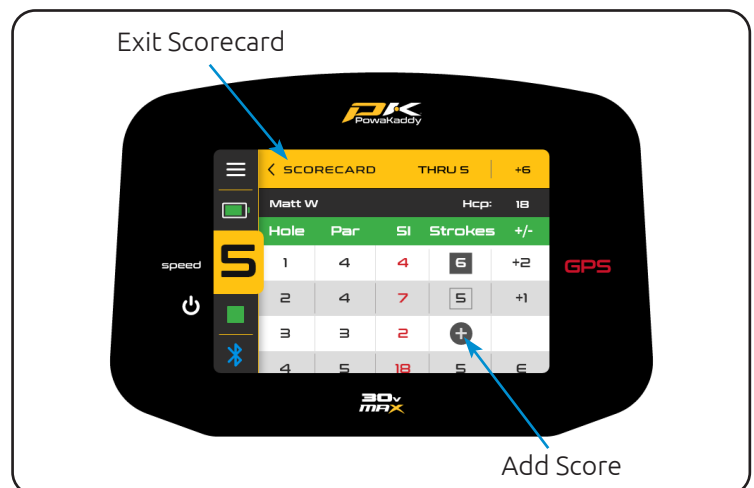
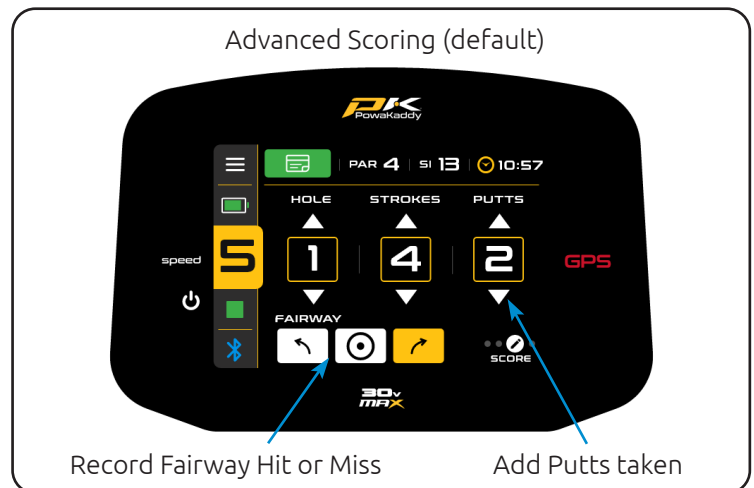
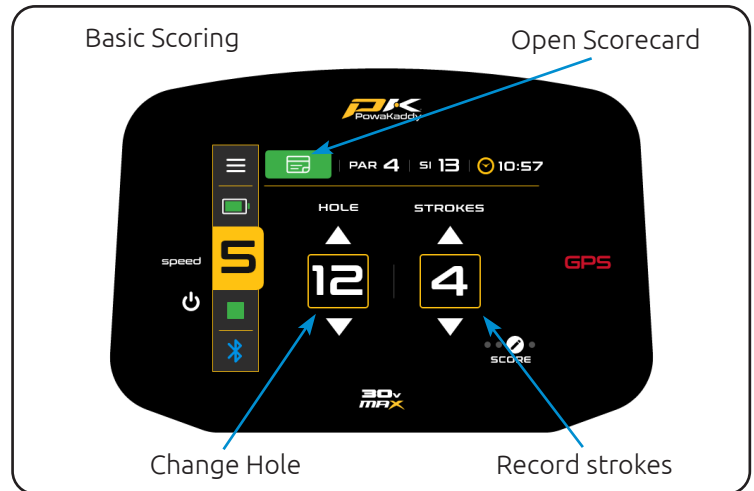

END ROUND

To end your round, open the Settings menu (top left-hand corner) and select the red 'End Round' option. You will be presented with a score summary.

From here, exit back to the GPS screens to continue the round or edit a score, view the round stats; time, trolley distance and advanced stats (if entered using the advanced scoring option).

These include greens in regulation (GIR), number of putts, average putts per hole and more.

If you wish to proceed and finish the round, confirm this by pressing the red 'Home' button.

Your completed round and stats is accessible to view on the App.

Note: your phone must be paired to the trolley (when powered & App open) for the scorecard to sync.

The trolley can store up to 10 rounds. These scorecards will be deleted and replaced unless synced to the App.

We recommend running the App in the background whilst playing.

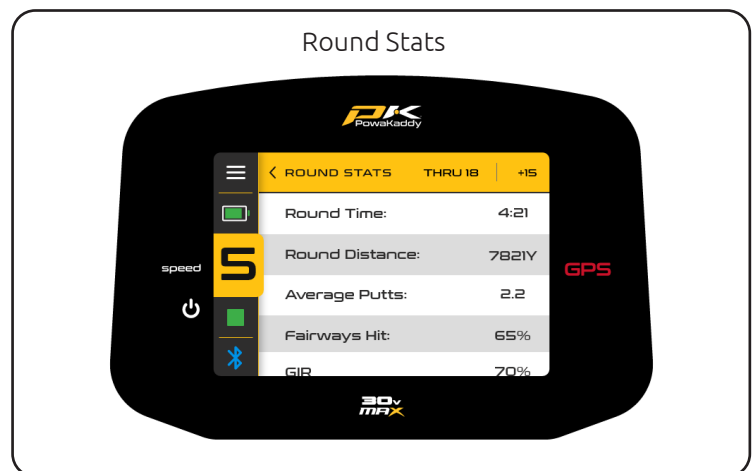
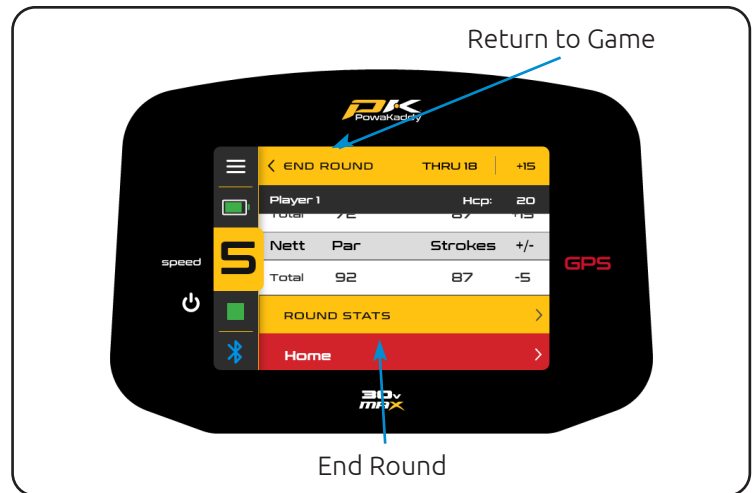

SETTINGS

Access the Settings menu via the icon in the top right-hand corner of the display.

Enter sub menu's using the arrows on the right-hand side. Touch a grey toggle switch icon to turn it on; it will turn yellow to indicate it is active. Press again to turn off.

To select an option within a list, simply press it. The yellow tick icon will indicate what selection is active.

The main options you may wish to change are split into two sub menus: 'Score Settings' and 'Trolley Settings'.

Score Settings

- Change game modes between Strokeplay and Stableford.
- Change between Advanced and Basic score entry modes.
- Set your handicap using the Left and Right arrows.
- Apply a handicap percentage if playing a match (true handicap will be displayed in brackets on the scorecard)
- Change between Men's and Women's Tees.

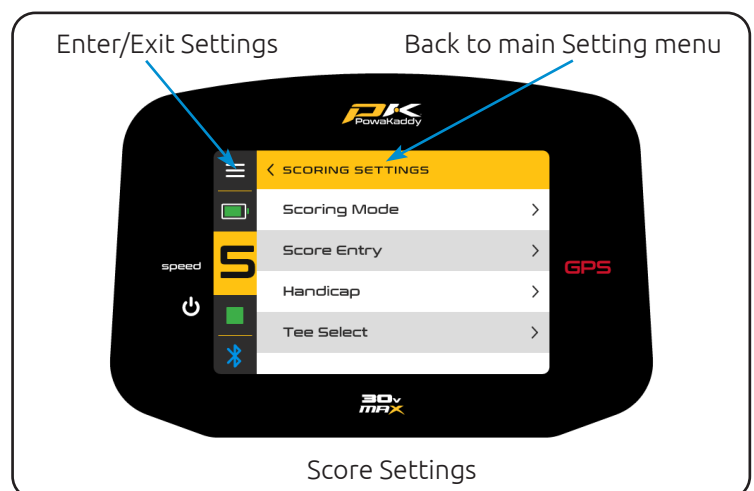

Trolley Settings

- Change the distance units from yards to metres.
- Adjust the clock and apply daylight saving setting.
- Set a security pin which when active, will be required when the trolley is powered up.
- Turn the Bluetooth on and off.
- Set a different language.
- Turn Demo mode on and off.

Note: A default pin of 7921 is used if ever you forget the set security pin code.

About

The final sub menu is the 'About' screen. Here you will find:

- Trolley firmware versions (When contacting customer service regarding a technical issue, they may request the software versions found here).
- History showing the trolley odometer & run time.
- 'Check for updates'. (Note: the trolley must be paired to the App. Follow instructions on screen and on the App.)

Exit the settings at any time via the icon in the top right-hand corner of the display.

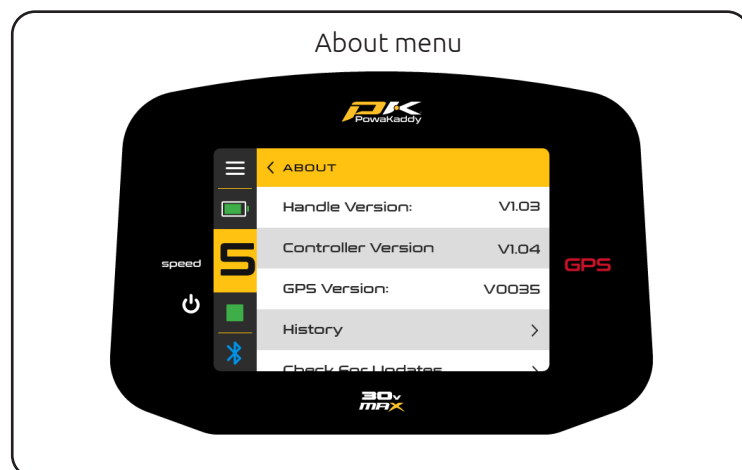
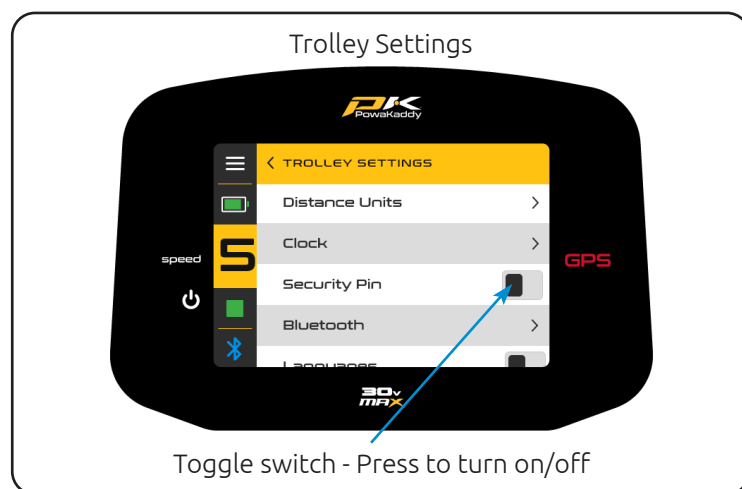

BATTERY CARE

Note: the STANDARD 30V Lithium Battery is designed for use over 18 holes and must always be fully charged before the next round. Please follow charging instructions as outlined on the following pages. We are aware that some golfers will try to stretch these batteries to 27 holes. This may damage the overall capacity of the battery and may result in an early failure. Playing more than 18 holes with the STANDARD battery can seriously shorten the battery's life and will invalidate the battery's warranty.

Note: in normal conditions the XL Extended 30V Lithium Battery will do 36 Holes when used on a PowaKaddy product. Conditions such as long or exceptionally hilly courses, wet ground conditions and excessively heavy golf bags may reduce the range of the trolley.

Charging Instructions

1. Plug the charger into the mains - the charger indicator light will be green.
2. Turn on the battery by press and holding the power button until the green light is illuminated.
3. Plug the battery into the charger. The charger light will turn from green to red to indicate the charging process has started.
4. Once the battery is fully charged, the charger status light will be continuous green. At this point, remove the battery from the charger and the charger from the outlet.
5. Turn off the battery using power button.
6. The charging process will take approximately 8 hours depending on the extent of the discharge and battery capacity.
7. Avoid leaving your battery on charge for longer than 12 hours. If left for a long period of time, the battery will automatically turn off.

Please note: if the red and green lights are flashing on the charger, this will indicate that:

- a. The battery was not turned on when connected to the charger.
- b. The charge cycle has finished, and the battery has turned off.
- c. There may be a fault with the battery or charger, please contact PowaKaddy technical support.

Battery Safety

- Never short circuit a battery. Keep it away from paper clips, coins, keys and other small metal objects that can make a connection between the terminals.
- Do not splash or immerse in liquids.
- Do not store or charge the battery in locations where the temperatures may exceed below -10° (14° F) or above 40° C (105° F) such as outdoor sheds or metal buildings in summer.
- Only charge your PowaKaddy battery using the approved charger supplied. Using another charger may damage the battery or cause fire.
- Never use the battery if the casing or terminals are damaged.
- There are no serviceable parts within the battery, DO NOT ATTEMPT TO OPEN THE BATTERY or attempt a repair.
RISK OF ELECTRIC SHOCK OR FIRE.
- The battery is a sealed unit. In the unlikely event liquid leaks from the battery, do not touch the liquid as it may cause irritation or burns.

Follow these precautions:

- Skin contact – Wash with soap and water.
 - Inhalation – Expose to fresh air and seek medical advice.
 - Eye contact – Immediately wash with water for at least 15 minutes. Seek medical attention.
 - Disposal – wear gloves to handle the battery and dispose of immediately; contact your local council or recycling centre.
- Do not incinerate the battery even if damaged.
 - Only use a PowaKaddy Battery with a compatible PowaKaddy Trolley. Use of the battery pack on other products may create risk of injury or fire.

Charging Safety

- Do not probe terminals with conductive objects.
- Only charge a PowaKaddy battery using the supplied PowaKaddy charger. The charger and battery pack are specifically designed to work together.
- Only charge on a hard, flat surface.
- The charger will get warm. Do not cover the charger or the battery.
- Do not expose the charger to rain, frost, or snow.
- Do not use a charger if the plug, leads, contacts or casing is damaged.
- Remove the plug with care. Do not pull on the cord.
- Avoid using an extension cable.

Lithium Battery Storage

Batteries are to be stored in a cool and dry place away from direct sunlight and excessive heat or cold; ideally store at room temperature. Charge your battery fully before storing. Charge once every three months thereafter.

Battery Transportation

Ensure the battery is turned off when transporting the trolley to avoid activating the trolley and discharging the battery. Check with your airline before attempting to ship your battery by air.

Lithium Battery Disposal

At the end of its useful life, please discard the battery with due care for the environment.

1. If possible, run down the battery completely and remove from the trolley.
2. Take the battery to your local recycling centre.

MAINTENANCE

Your Powakaddy trolley is easy to maintain.

1. Store your trolley inside.
2. Never jet wash or immerse in water. Clean the trolley using a sponge and warm water to remove mud, grass, and other debris.
3. Occasionally remove the wheels and apply grease to the axles and wheels.
4. Only use approved Powakaddy parts for repairs.

Your serial number can be found in the cavity of the rear joint, please make a note for future reference.

Should you experience a problem with your Powakaddy product, please visit www.powakaddy.com/support



The POWAKADDY name and PK logo are registered trade marks of Powakaddy International Limited and are protected in the UK and other countries and regions. In addition, Powakaddy International Limited owns various design registrations, patents and other IP rights in connection with their products.

Only Powakaddy International Ltd and its authorised stockists and licensees may use the Powakaddy logo, product logos and images in advertising, promotional and sales materials, subject to terms and conditions.

Powakaddy International Ltd is registered in UK. Company No. 07747629, UK Trade Mark Registration No. 3593096



Register now!
Don't miss out!

Scan to open the registration page
or visit: powakaddy.com/my-powakaddy



PGA is a registered trade mark of the Professional Golfers' Association Limited.